

About this Manual

We've added this manual to the Agilent website in an effort to help you support your product. This manual is the best copy we could find; it may be incomplete or contain dated information. If we find a more recent copy in the future, we will add it to the Agilent website.

Support for Your Product

Agilent no longer sells or supports this product. Our service centers may be able to perform calibration if no repair parts are needed, but no other support from Agilent is available. You will find any other available product information on the Agilent Test & Measurement website, www.tm.agilent.com.

HP References in this Manual

This manual may contain references to HP or Hewlett-Packard. Please note that Hewlett-Packard's former test and measurement, semiconductor products and chemical analysis businesses are now part of Agilent Technologies. We have made no changes to this manual copy. In other documentation, to reduce potential confusion, the only change to product numbers and names has been in the company name prefix: where a product number/name was HP XXXX the current name/number is now Agilent XXXX. For example, model number HP8648A is now model number Agilent 8648A.

AM Radio Tests
HP 11807A,E Option 003
Reference Guide
for the HP 8920A,B

HP Part No. 11807-90118
Printed in U. S. A.
January 1995

Rev A

RESTRICTED RIGHTS LEGEND

Copyright © Hewlett-Packard Company 1995

RESTRICTED RIGHTS LEGEND

Use, duplication or disclosure by the U.S. Government is subject to restrictions as set forth in subparagraph (c) (1) (ii) of the Rights in Technical Data and Computer Software clause in DFARS 252.227-7013.

Hewlett-Packard Company
3000 Hanover Street
Palo Alto, CA 94304
U.S.A.

Rights for non-DOD U.S. Government Departments and Agencies are as set forth in FAR 52.227-19 (c) (1,2).

Contents

1 Product Description

HP 11807A,E Software 16

Finding the Information You Need 19

Additional Services Available 20

Contents

A.14.00	2 Using the Software/HP 8920B, or HP 8920A FW Above Rev.
	Testing Overview 24
	Customizing Testing 30

Contents

	3 Using the Software/HP 8920B, or HP 8920A FW Below Rev.
A.14.00	
	Testing Overview 56
	Customizing Testing 62

4 Test, Parameter, and Pass/Fail Limit Descriptions

Introduction 86

TEST_01. TX and RX Stand-by Current Drain 87

TEST_02. TX Frequency Error 88

TEST_03. TX Output Power 89

TEST_04. TX Audio Frequency Response 90

TEST_05. TX Audio Distortion 91

TEST_06. TX Microphone Sensitivity 92

TEST_07. TX AM Hum and Noise 93

TEST_08. RX Hum and Noise 94

TEST_09. RX Audio Distortion 95

TEST_10. RX Audio Frequency Response 96

TEST_11. RX Sensitivity S/N 97

TEST_12. RX Sensitivity SINAD 98

TEST_13. RX Audio Squelch Sensitivity 99

TEST_14. RX Automatic Gain Control 100

TEST_15. RX Quick General 101

TEST_16. TX Quick General 102

Test Parameter Descriptions 103

Parameter 1. RT External Pad and Cable Loss 104

Contents

Parameter 2. RT High Supply Voltage	105
Parameter 3. RT Low Supply Voltage	106
Parameter 4. RT Nominal Supply Voltage	107
Parameter 5. RT Test At Extreme Settings	108
Parameters 6–8. RX AGC Start, Step, and Stop RF Levels	109
Parameter 9. RX Audio Freq Response Reference Freq	110
Parameters 10-12. RX Audio Freq Response Start, Step, and Stop Frequencies	111
Parameter 13. RX Audio Load Impedance	112
Parameter 14. RX Maximum Audio Power	113
Parameter 15. RX Sens S/N Set and Meas	114
Parameter 16. RX Sens SINAD Set and Meas	115
Parameter 17. RX Sensitivity S/N Level	116
Parameter 18. RX Sensitivity SINAD Level	117
Parameter 19. RX Set Radio Volume	118
Parameter 20. RX Sq Sens RF Input When Setting Volume	119
Parameter 21. RX Standard RF Input Level	120
Parameter 22. RX Standard Test Modulation	121
Parameter 23. RX Tolerance For Setting Volume	122
Parameter 24. TX AM Hum and Noise Modulation	123
Parameter 25. TX Audio Distortion Modulation	124

Contents

Parameter 26. TX Audio Freq Response Modulation	125
Parameter 27-29. TX Audio Freq Response Start, Step, and Stop Frequencies	126
Parameter 30. TX Dekey Between TX Tests	127
Parameter 31. TX Mic Sens Set and Measure	128
Parameter 32. TX Microphone Sensitivity Modulation	129
Parameter 33. TX User/System Key UUT	130
Parameter 34. XX Secure Frequency Information	131
Pass/Fail Limit Descriptions	132
Pass/Fail Limit 1. RX AGC Distortion At >50% Audio Levels	133
Pass/Fail Limit 2. RX AGC Performance	134
Pass/Fail Limit 3. RX Audio Distortion	135
Pass/Fail Limit 4. RX Audio Frequency Response Error	136
Pass/Fail Limit 5. RX Hum and Noise Squelched	137
Pass/Fail Limit 6. RX Noise and Hum Unsquelched	138
Pass/Fail Limit 7. RX Sensitivity S/N	139
Pass/Fail Limit 8. RX Sensitivity SINAD	140
Pass/Fail Limit 9. RX Stand-By Current Drain	141
Pass/Fail Limit 10. RX Threshold Squelch Sensitivity	142
Pass/Fail Limit 11. RX Tight Squelch Sensitivity	143
Pass/Fail Limit 12. TX AM Hum and Noise	144

Contents

Pass/Fail Limit 13. TX Audio Distortion	145
Pass/Fail Limit 14. TX Audio Frequency Resp Roll >2500 Hz	146
Pass/Fail Limit 15. TX Audio Frequency Response Error	147
Pass/Fail Limit 16. TX Carrier Power	148
Pass/Fail Limit 17. TX Carrier Power At High Supply	149
Pass/Fail Limit 18. TX Carrier Power At Low Supply	150
Pass/Fail Limit 19. TX Current Drain	151
Pass/Fail Limit 20. TX Frequency Error	152
Pass/Fail Limit 21. TX Microphone Sensitivity	153
Pass/Fail Limit 22. TX Modulation If Set and Meas Mic Sens	154

5 Reference (Alphabetical)

Conventions Used 156

Copying Files 157

Data Collection (Saving and Retrieving Test Results) 159

Disks 169

Exiting a Program 171

HP-IB Control Annunciators 172

Memory Cards 173

Parameters 181

Pass/Fail Limits (specifications) 182

Pausing or Stopping a TEST 183

Printing 184

Procedures 198

RAM 204

Saving Tests Results 206

Serial Port 207

Test Execution Conditions 209

USER Keys 211

Contents

6 Problem Solving

If You Have a Problem Testing Your Radio 214

If the test procedure doesn't run on an test set 215

If the HP 11807A,E program was incorrectly loaded 216

If the printer does not print the test results 217

If you can't get the data-collection function to work 219

If the AM radio fails the audio tests 221

If radio volume can't be set on the test set meter screen 222

Contents

Glossary 223

Contents

Index 227

Contents

Product Description

HP 11807A,E Software

The HP 11807A,E Option 003, Radio Test Software is used for automated testing of AM radios. Software is written on One-Time Programmable (OTP) memory cards shown below. The Test Set's built-in computer (operating with HP Instrument BASIC programming language) allows automated measurements for quick-functional, or full-parametric testing.

- Quick-functional testing of AM radios is done using the pre-written Test Procedure “**AM_TEST**” on the OTP memory card.
- Also, user-defined Test Procedures may be created for full-parametric testing to meet your radio-specific testing needs. The user-defined Test Procedures are saved onto the Static Random-Access Memory (SRAM) memory card which is provided with each HP 11807A,E option.

Materials Included in This Package

This package contains the following materials. Verify that all of the materials are present and inspect for damage. If a part is missing or appears to be damaged, contact your nearest Hewlett-Packard sales or service office.

- HP 11807A Option 003 Test Software (part number 11807-10003) OR HP 11807E Option 003 Test Software (part number 11807-10022).
- SRAM memory card (uninitialized), for saving your own test procedures and results.
 - For HP 11807A, 32 Kbyte SRAM (part number HP 85700A).
 - For HP 11807E, 64 Kbyte SRAM (part number HP 83230A).
- HP 11807A,E Option 001 Software Reference Guide (part number 11807-90118).
- HP software product license agreement

Hardware Configurations

The HP 11807A,E Option 003 software requires the test set to be configured with the following hardware:

- 512k RAM Memory extension, HP 8920A Option 005

Recommended Equipment

Other hardware configurations for your test set are recommended, but not required:

- High-Stability Timebase, HP 8920A,B Option 001

External Power Supplies

An external dc power supply for the cellular phone can be configured to the HP 8920A,B in one of three ways:

1. A power supply or battery can be connected directly to the cellular phone.
2. A power supply can be connected to the rear-panel DC CURRENT MEASUREMENT banana-plug connectors. (This requires the HP 8920A Option 003, HP-IB/RS-232/Current Measurement.)
3. A power supply can be controlled by the test set when it is connected to the HP-IB connector. (This requires the HP 8920A,D Option 003, HP-IB/RS-232/Current Measurement.)

HP-IB programmable power supply from the following series are supported for external control:

HP 664xA
HP 665xA
HP 667xA
HP 668xA

NOTE:

The HP 662xA and HP 663xA series dc power supplies do not use SCPI commands and are not supported.

Available Tests

The following tests can be performed with this software:

- TX and RX Stand-by Current Drain
- TX Frequency Error
- TX Output Power
- TX Audio Frequency Response
- TX Audio Distortion
- TX Microphone Sensitivity
- TX AM Hum and Noise
- RX Hum and Noise
- RX Audio Distortion
- RX Audio Frequency Response
- RX Sensitivity S/N
- RX Sensitivity SINAD
- RX Audio Squelch Sensitivity
- RX Automatic Gain Control
- RX Quick General
- TX Quick General

For test, parameter, and pass/fail limit descriptions, see [chapter 4, "Test, Parameter, and Pass/Fail Limit Descriptions," on page 85](#).

Finding the Information You Need

This manual describes the setup and use of the HP 11807A,E Software with the HP 8920A,B,D test set. The book is arranged in self-contained chapters to provide the following information:

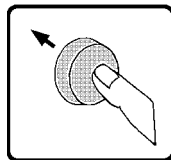

PRODUCT DESCRIPTION CHAPTER 1

- Fast paced, hands on tutorial.
- Basic test set/software operation.
- First time or occasional users.

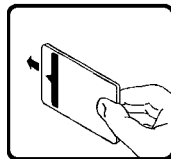

USING THE SOFTWARE-CHAPTER 2

- How to load
- How to run
- How to customize
- Conceptual overview
- Instructions for cabling test set.

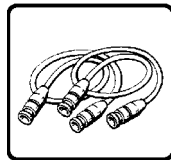

TEST DESCRIPTIONS-CHAPTER 4

Definitions, special conditions and restrictions for:

- Tests
- Specifications-Pass/fail limits
- Parameters-Test conditions



REFERENCE-CHAPTER 5

- Alphabetically listed
- Detailed descriptions of all the features and functions of the software.
- For the advanced level user.



PROBLEM SOLVING-CHAPTER 6

- Alphabetically listed
- Symptoms and possible corrections to frequent user problems.

MANUAL1

Additional Services Available

Consult the HP 8920 User's Guide or call the HP 8920 Hotline 1-800-922-8920 (in the USA and Canada only) and give your software model number.

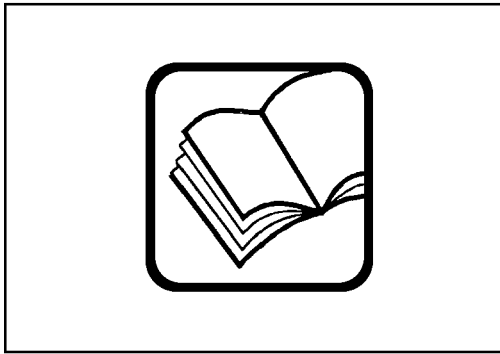

TROUBLE1

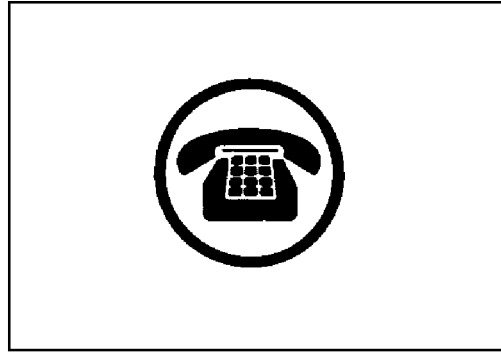

**Using the Software/HP 8920B, or HP
8920A FW Above Rev. A.14.00**

NOTE:

The firmware revision A.14.00 in the HP 8920A,D had several enhancements, which are standard in the HP 8920B. This chapter applies to users with:

- **HP 8920A test sets with firmware revision above A.14.00**
- **All HP 8920B test sets.**

The test set's firmware revision is displayed on the top right corner of the configuration screen.

- Press SHIFT CONFIG to display the configuration screen and read the firmware revision.

If you have an HP 8920A test set with firmware revision below A.14.00, refer to [chapter 3, "Using the Software/HP 8920B, or HP 8920A FW Below Rev. A.14.00," on page 53](#). Contact Hewlett-Packard at 1-800-922-8920 for details on upgrading your firmware if desired.

The software can be run on the factory default settings or customized to your individual needs and specific requirements. This chapter provides detailed information on how to load, run, and customize the software.

The test set has two methods of accessing on-line help. In each of the screens in the test environment, k4 (**He1p**) accesses specific information about how to set up/use the current screen. SHIFT HELP accesses the master help file, with an alphabetical listing of help topics.

Testing Overview

Pressing TESTS will display what is called the TESTS (Main Menu) screen. To begin testing, you must first load the software and make connections. From this screen you have the option to:

Begin running tests:

- The factory default settings are acceptable for your application or
- The software has already been customized and saved to a memory card

Customize the software:

- Decide which tests you desire to run (Order of Tests)
 - you may want to run all, some, or just one of the tests.
- Specify which channels to test (Channel Information)
 - you may want to test one, some, or all of the channels on your radio.
- Change the pass/fail limits for specific measurements (Pass/Fail Limits)
 - you may want the pass/fail limits to have tighter or looser specifications than the default settings.
- Change the test environment and conditions (Test Parameters)
 - decide output format.
 - enter specific information about radio equipment and/or environment.
- Save any or all of the above customized changes to a memory card (Save/Delete Procedure)

Set Up Test Set:

- Print test results or certain screens.
- Decide when and where test results are displayed (**Execution Conditions/Printer Setup**)

To Run Tests

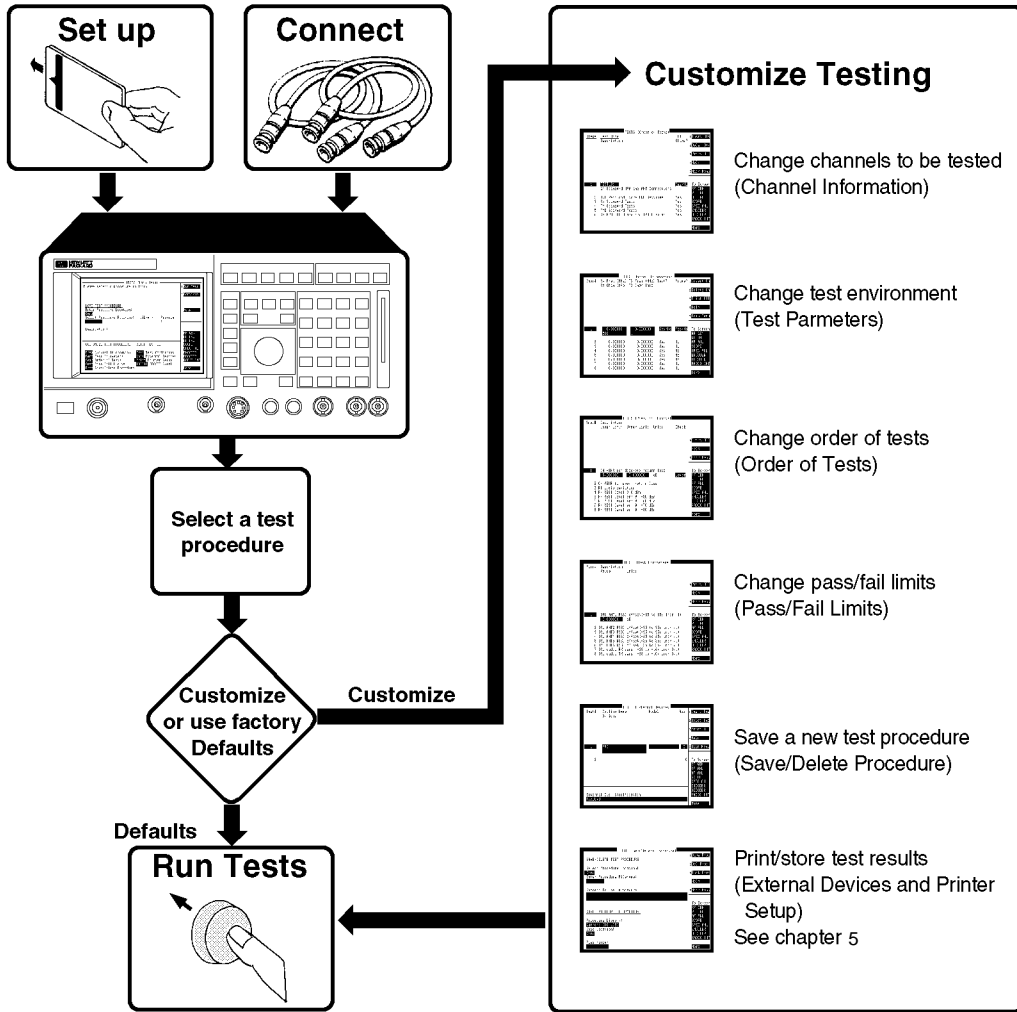

OVERVIEW1

Setting Up the Test Set and Making Connections

Before you begin testing, you must set up the test set and make the appropriate hardware connections.

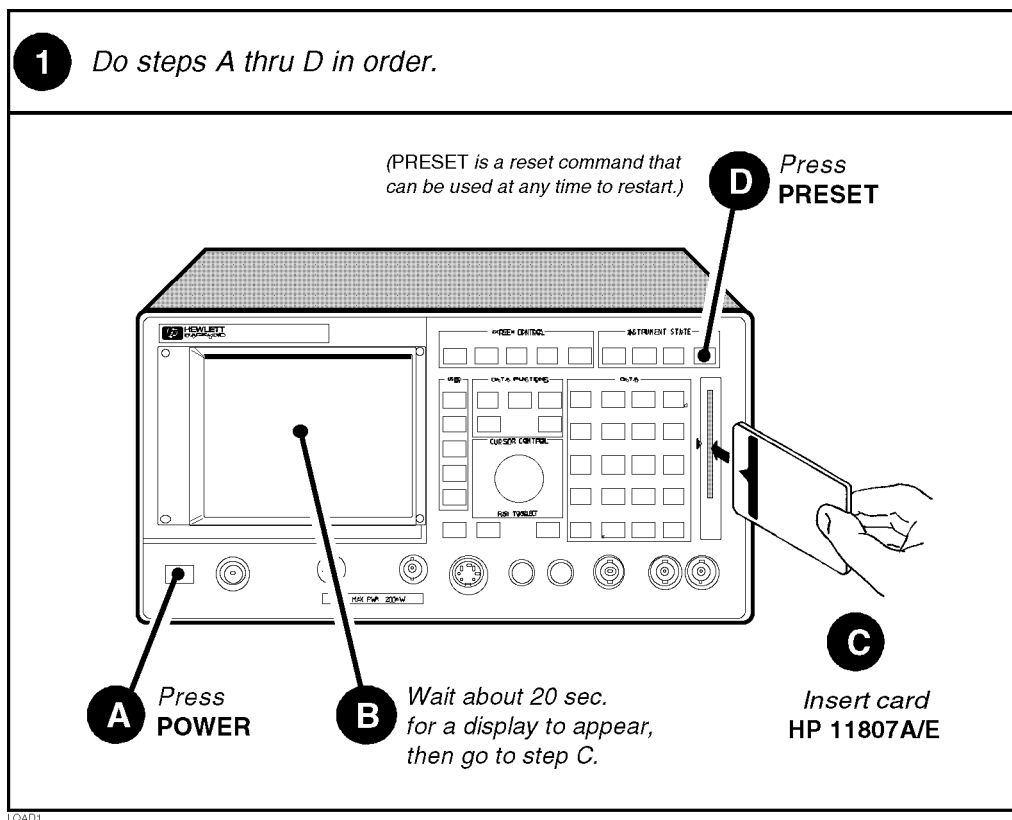

Continue on next page

Making a Connection

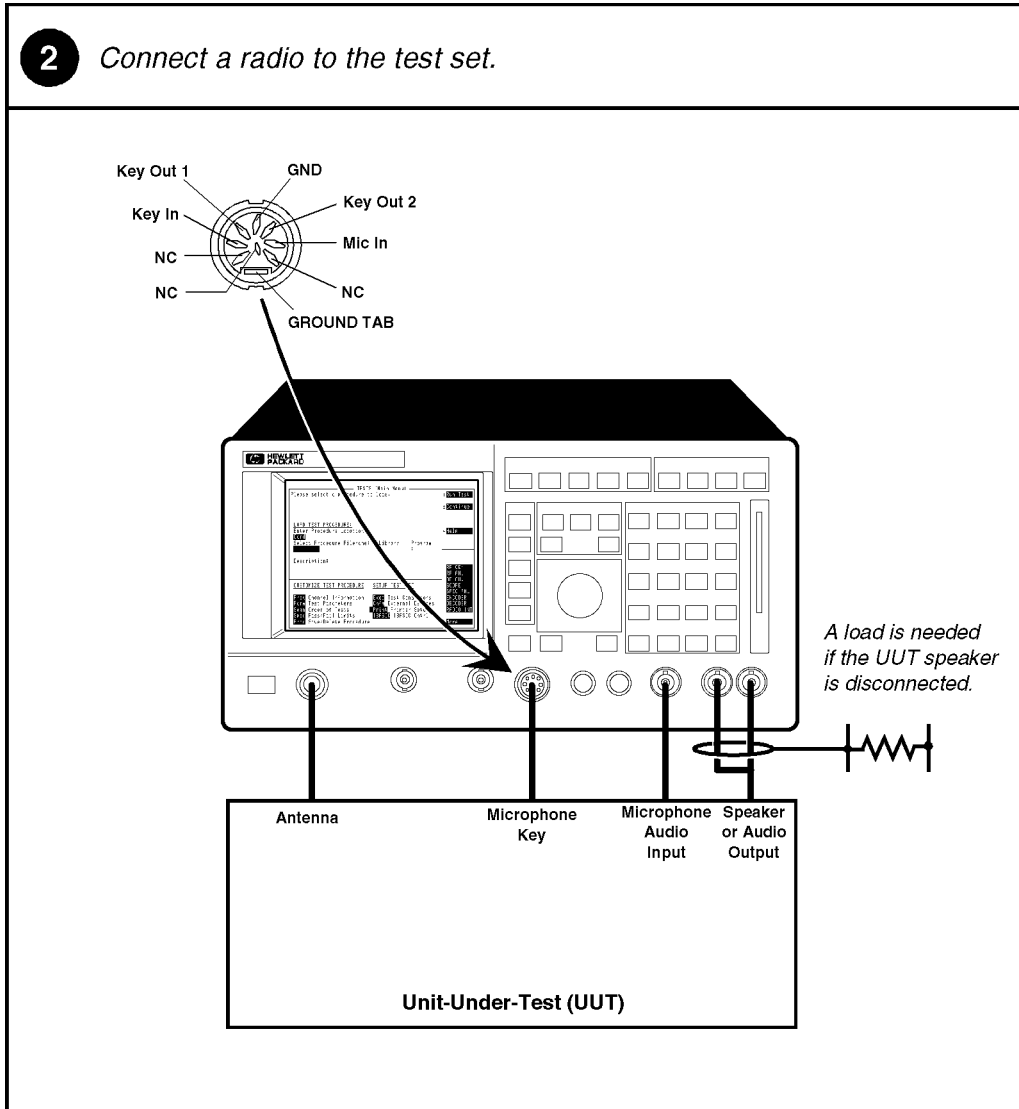

Selecting a Test Procedure









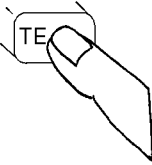

To load the software, you must first select the location to load from (in this case, it will be **Card**) and a procedure filename. Your card comes pre-programmed with at least one procedure. The actual software program does not get loaded into the test set's memory until k1 (**Run Test**) is selected. It will take approximately 15 seconds to load the software in an HP 8920B, and approximately two minutes in an HP 8920A,D.

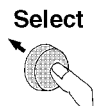
The software memory card can be removed after the program is loaded into the test set's memory. The program will remain in memory after a power-down/ power-up cycle, unless it is manually deleted or a new program is loaded.

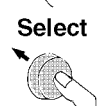
When tests begin to run, they are executed in the order in which they were entered into the Test Procedure.

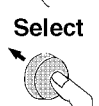
Pressing CANCEL will pause the current test (press k2 to continue the test.)

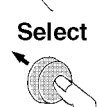
Selecting A Test Procedure

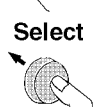
<p>1 Press TESTS to display the TESTS screen.</p>	<p>2 Position cursor and select Enter Procedure Location:.</p>
<p>If you are in IBASIC, press SHIFT, CANCEL before pressing TESTS.</p> 	<p>Position</p>  <p>Select Procedure Location:</p> 
<p>3 Position cursor and select Card.</p>	<p>4 Position cursor and select Select Procedure Filename:.</p>
<p>Position</p>  <p>Select</p>  <p>Choices :</p> <ul style="list-style-type: none"> <input checked="" type="checkbox"/> Card <input type="checkbox"/> ROM <input type="checkbox"/> RAM <input type="checkbox"/> Disk 	<p>Position</p>  <p>Select Procedure Filename:</p> 
<p>5 Position cursor and select desired Procedure.</p>	<p>6 Position cursor and select RUN TEST.</p>
<p>Position</p>  <p>Select</p>  <p>Choices :</p> <ul style="list-style-type: none"> <input checked="" type="checkbox"/> XXXXXX <input type="checkbox"/> XXXXXX <input type="checkbox"/> XXXXXX <input type="checkbox"/> XXXXXX 	<p>Position</p>  <p>Select</p>  <p>Procedures may take 2-3 minutes to load.</p> <ul style="list-style-type: none"> <input checked="" type="checkbox"/> Run Test <input type="checkbox"/> 2 Continue <input type="checkbox"/> 4 Help

PROCD1

Customizing Testing

Because of the diversity of individual testing needs, the software has been designed so that changes may be easily made from the test set's front panel. You may store these changes on a memory card so that you may skip these steps in the future. See **"Saving a Test Procedure" on page 47**.

Because your needs change, the software allows changes to its default settings whenever you need to make them. For example, tests may be inserted or deleted, and later after running the tests you can change the pass/fail limits or decide to test different channels.

Most testing customization is accomplished through the customization screens. These customization screens are accessed from the main TESTS (Main Menu) screen as shown in the following figure. Customizing procedures is explained later in this chapter.

NOTE:

External Devices, Printer Setup, and IBASIC will not be explained in this customizing section.

- External Devices and Printer Setup are used when setting up printers and external disk drives which is explained in **"Disks" in chapter 5 on page 169** and **"Printing" in chapter 5 on page 184**.
 - IBASIC is used when writing your own programs and is not explained in this manual. If you need to write your own IBASIC programs you may acquire the following manuals:
 - HP 8920A,D
 - *HP Instrument Basic User's Handbook* HP part number E2083-90000.
 - *HP 8920A Programming Manual* HP part number 08920-90220.
 - HP 8920B
 - *HP Instrument Basic User's Handbook Version 2.0* HP part number E2083-90005.
 - *HP 8920B Programming Manual* HP part number 08920-90222.
-

How to Customize Testing

TESTS Screen

TESTS (Main Menu)

Please select a procedure to load.

1 Run Test
2 Continue
4 Help

LOAD TEST PROCEDURE:
Select Procedure Location:
Card
Select Procedure Filename: Library: Program:
Description:

CUSTOMIZE TEST PROCEDURE: SET UP TEST SET:

Free Channel Information	Exec Execution Cond
Parm Test Parameters	Cnfg External Devices
Seqn Order of Tests	Print Printer Setup
Spec Pass/Fail Limits	IBASIC IBASIC Cntrl
Proc Save/Delete Procedure	

To Screen
RF GEN
RF ANL
AF ANL
SCOPE
SPEC ANL
ENCODER
DECODER
RADIO INT
More

Selecting a Test Function opens a Customization Screen.

CUSTOM

Changing the Order of Tests



You may define the order of tests to include all, some, or just one of the tests available. When the first test is finished, the next will run. The test sequence will remain in the test set's battery backed-up memory until another test sequence is loaded or set up. For information on saving a customized test sequence, see ["Saving a Test Procedure" on page 47](#).

Defining the order of tests is accomplished by inserting or deleting tests from the list of tests that come with the software package. See [chapter 4, "Test, Parameter, and Pass/Fail Limit Descriptions," on page 85](#), for descriptions of tests included in this package.

The **All Chans?** field allows the user to decide to run the test on all channels entered in the **Channel Information** table, or just the channels which are selected as **Prime** in the **Channel Information** screen. This feature allows the user the flexibility to use channels that are selected as **Prime** in all the tests in the sequence, and those indicated as non-prime in a subset of tests (those tests with a **Yes** response in **All Chans**). For more information, see ["Specifying Channel Information" on page 36](#).



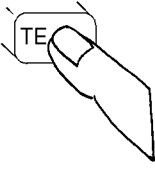









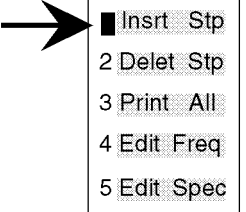

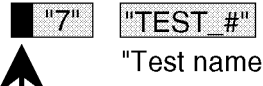

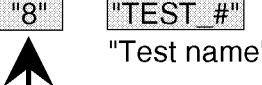
The following describes how to create a new test sequence and enter a response to the **All Chans?** field.

How to Change the Order of Tests

<p>1 Press TESTS to display the TESTS screen.</p>	<p>2 Position cursor and select Seqn Order of Tests.</p>															
<p>If you are in IBASIC, press SHIFT, CANCEL before pressing TESTS.</p> 	<table border="1"> <tr> <td>Position</td> <td></td> <td>Freq Channel Information</td> </tr> <tr> <td></td> <td></td> <td>Parm Test Parameters</td> </tr> <tr> <td></td> <td></td> <td>Seqn Order of Tests</td> </tr> <tr> <td>Select</td> <td></td> <td>Spec Pass Fail Limits</td> </tr> <tr> <td></td> <td></td> <td>Proc Save/Delete Procedure</td> </tr> </table>	Position		Freq Channel Information			Parm Test Parameters			Seqn Order of Tests	Select		Spec Pass Fail Limits			Proc Save/Delete Procedure
Position		Freq Channel Information														
		Parm Test Parameters														
		Seqn Order of Tests														
Select		Spec Pass Fail Limits														
		Proc Save/Delete Procedure														
<p>The Order of Tests screen is now present on your CRT.</p>	<p>3 Position cursor and select Step # field.</p> <table border="1"> <tr> <td>Position</td> <td></td> <td colspan="2">Example</td> </tr> <tr> <td></td> <td></td> <td>"1"</td> <td>"TEST_5"</td> </tr> <tr> <td>Select</td> <td></td> <td>↑</td> <td>"Test name"</td> </tr> </table>	Position		Example				"1"	"TEST_5"	Select		↑	"Test name"			
Position		Example														
		"1"	"TEST_5"													
Select		↑	"Test name"													
<p>4 Rotate knob until Step # which precedes the insertion point of the new test you are adding is highlighted, then select it.</p>																
<p>Rotate</p>  <p>Select</p> 	<p>For example, select step 7 if you want to insert the new test as step 8.</p> <table border="1"> <tr> <td>"7"</td> <td>"TEST_#"</td> </tr> <tr> <td></td> <td>"Test name"</td> </tr> <tr> <td>"8"</td> <td>"New test"</td> </tr> </table>	"7"	"TEST_#"		"Test name"	"8"	"New test"									
"7"	"TEST_#"															
	"Test name"															
"8"	"New test"															

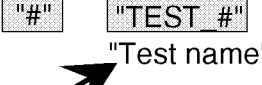
SEQ1

Continue on next page

<p>5 <i>Position cursor and select Insrt Stp.</i></p>	<p>6 <i>Position cursor back at Step # field and select it.</i></p>
<p>Position</p>  <p>Select</p>  	<p>Position</p>  <p>Select</p>  
<p>7 <i>Highlight and select Step # field of newly inserted test.</i></p>	<p>8 <i>Position cursor and select Test Name field.</i></p>
<p>Highlight</p>  <p>Select</p>  	<p>Position</p>  <p>Select</p>  
<p>9 <i>Rotate knob and select desired Test Name when it appears.</i></p>	<p>10 <i>Position cursor at All Chans? field and select Yes or No.</i></p>
<p>Rotate</p>  <p>Select</p>  	<p>Position</p>  <p>Select</p>   <p><i>(Press the knob to change the selection.)</i></p>

SEQ2

Continue on next page

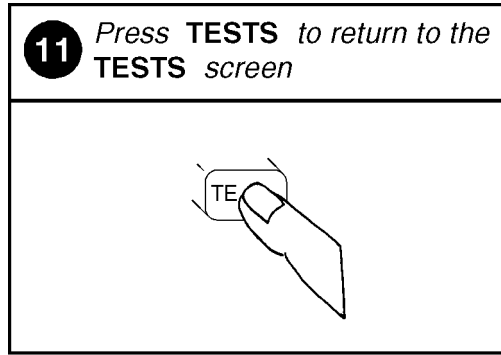

Specifying Channel Information

For each channel that you wish to specify, you must enter the following information into the **Channel Information** screen:

- RX Freq (MHz)
 - Enter the receive frequency in MHz.
- TX Freq (MHz)
 - Enter the transmit frequency in MHz.
- **Test?** (yes/no) specifies whether you want to test the UUT at this channel. If set to “No” then the UUT will not be tested at that channel, but you may retain the channel information in the table for later use. If set to “Yes” then the channel will be used as defined by settings of **Prime?** and **All Chans?** fields.
- **Prime?** (yes/no) specifies which channels are “prime”. Select “Yes” if you want to test the UUT at this channel on all the tests in the procedure. Select **No** if you want to test the UUT at this channel on just a subset of tests, which are designated by selecting **Yes** in the **All Chans** field of the **Order of Tests** screen. See **All Chans?** in ["Changing the Order of Tests" on page 32](#) for more information.

For information on saving the channel information table, see ["Saving a Test Procedure" on page 47](#).

The **All Chans** field in the **Order of Tests** screen interacts closely with the **Prime?** field on the **Channel Information** screen. When the software runs, it begins by retrieving the first channel entered into the **Channel Information** screen. It then checks the response in the **Test?** field to determine if the UUT should be tested at that channel at this time. If there is a **No** response in the **Test?** field, the software will go to the next channel in the table. If there is a **Yes** response in the **Test?** field, the software will check if the channel is **Prime**.

A **Yes** response in the **Prime?** field indicates to test the UUT at that channel on the entire sequence of tests in the procedure. A **No** response in the **Prime?** field indicates to test the UUT at that channel on a subset of tests in the procedure. The subset of tests is determined by a **Yes** response in the **All Chans?** field. Therefore, tests with a **No** response in the **All Chans?** field will be run on *prime* channels only.

Below is an example of how the software would run if you had a procedure set up as follows:

Table 1

Chan #	Test?	Prime?
Chan 01	Yes	Yes
Chan 02	Yes	No
Chan 03	No	No

Table 2

Test Number	All Chan? Setting
Test 01	No
Test 02	Yes
Test 03	Yes
Test 04	No

The result would be:











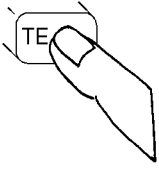

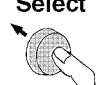

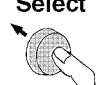

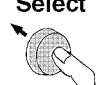

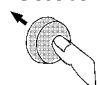



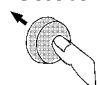



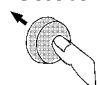



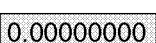



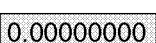



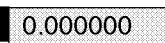
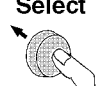

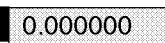
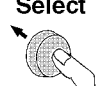

- Chan 01 is used in Test 01, Test 02, Test 03, and Test 04.
- Chan 02 is used in Test 02, and Test 03 only.
- Chan 03 is not used.

The following **table 3** shows how to properly configure these settings according to your testing needs.

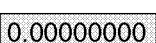
Table 3



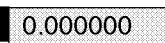
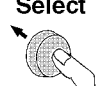





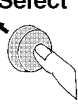

Testing Need	Necessary Field Settings		
	Test?	Prime?	All Chan?
Test channel on all tests in sequence	Yes	Yes	Don't Care
Test channel on a subset of tests in sequence	Yes	No	Yes on tests you want included in the testing subset
Do not test this channel now, but retain information for late ruse	No	Don't Care	Don't Care

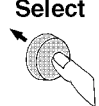
How to Specify Channel Information

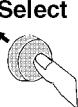
<p>1 Press TESTS to display the TESTS (Main Menu) screen.</p> <p><i>IF you are in IBASIC, press SHIFT, CANCEL before pressing TESTS.</i></p> 	<p>2 Position cursor at Freq Channel Info... and select it.</p> <table border="1"> <tr> <td>Position</td> <td></td> <td>Freq Channel Information</td> </tr> <tr> <td></td> <td></td> <td>Parm Test Parameters</td> </tr> <tr> <td></td> <td></td> <td>Seqn Order of Tests</td> </tr> <tr> <td></td> <td></td> <td>Spec Pass Fail Limits</td> </tr> <tr> <td>Select</td> <td></td> <td>Proc Save/Delete Procedure</td> </tr> </table>	Position		Freq Channel Information			Parm Test Parameters			Seqn Order of Tests			Spec Pass Fail Limits	Select		Proc Save/Delete Procedure
Position		Freq Channel Information														
		Parm Test Parameters														
		Seqn Order of Tests														
		Spec Pass Fail Limits														
Select		Proc Save/Delete Procedure														
<p>The Channel Information screen is now present on your CRT.</p>	<p>3 Position cursor at Chan # field and select it.</p> <table border="1"> <tr> <td>Position</td> <td></td> <td>(Disregard this number.)</td> </tr> <tr> <td></td> <td></td> <td></td> </tr> <tr> <td>Select</td> <td></td> <td></td> </tr> </table>	Position		(Disregard this number.)				Select								
Position		(Disregard this number.)														
																
Select																
<p>4 Scroll to Chan # field and select it.</p> <table border="1"> <tr> <td>Scroll</td> <td></td> <td>(This numbers are examples.)</td> </tr> <tr> <td></td> <td></td> <td> </td> </tr> <tr> <td>Select</td> <td></td> <td></td> </tr> </table>	Scroll		(This numbers are examples.)			 	Select			<p>5 Position cursor at RX Freq (MHz) field and select it.</p> <table border="1"> <tr> <td>Position</td> <td></td> <td> </td> </tr> <tr> <td>Select</td> <td></td> <td></td> </tr> </table>	Position		 	Select		
Scroll		(This numbers are examples.)														
		 														
Select																
Position		 														
Select																

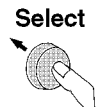
FREQ1

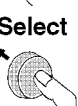
Continue on next page

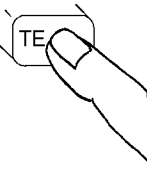
<p>6 Use DATA keys to enter new RX Freq, then select it.</p>	<p>7 Position cursor at TX Freq (MHz) field and select it.</p>
<p>Enter  Select </p> <p>6 "New #" (Enter your desired RX Freq)</p>	<p>Position  Select </p> <p>##### 0.000000 </p>
<p>8 Use DATA keys to enter new TX Freq, then select it.</p>	<p>9 Position cursor at Test? field and select Yes or No.</p>
<p>Enter  Select </p> <p>##### "New #" (Enter your desired TX Freq)</p>	<p>Position  Select </p> <p>Yes/No  (Press knob to change the selection.)</p>
<p>10 Position cursor at Prime? field and select Yes or No.</p>	<p>11 Press TESTS to return to the TESTS (Main Menu) screen.</p>
<p>Position  Select </p> <p>Yes/No  (Press knob to change the selection.)</p>	<p></p>







FREQ2

Changing Pass/Fail Limits

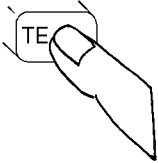
Pass/Fail limits define the values a measurement's result is compared against to determine if the UUT meets its specified standards. Default values are set in the test software. These default values may be changed to suit your particular requirements.





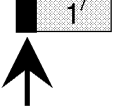





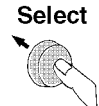

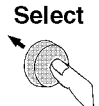
The following describes how to change the pass/fail (upper and lower) limits. See "[Pass/Fail Limit Descriptions](#)" in [chapter 4 on page 132](#) for descriptions of each pass/fail limit. For information on saving customized pass/fail limits, see "[Saving a Test Procedure](#)" on [page 47](#).

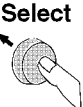
How to Change Pass/Fail Limits

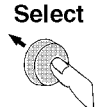
<p>1 Press TESTS to display the TESTS screen.</p> <p><i>IF you're in IBASIC, press SHIFT, CANCEL before pressing TESTS.</i></p> 	<p>2 Position cursor and select Spec Pass Fail Limits.</p> <table border="1"> <tr> <td>Position</td> <td></td> </tr> <tr> <td></td> <td>Freq Channel Information</td> </tr> <tr> <td></td> <td>Parm Test Parameters</td> </tr> <tr> <td></td> <td>Seqn Order of Tests</td> </tr> <tr> <td>Select</td> <td>Spec Pass Fail Limits</td> </tr> <tr> <td></td> <td>Proc Save/Delete Procedure</td> </tr> </table>	Position			Freq Channel Information		Parm Test Parameters		Seqn Order of Tests	Select	Spec Pass Fail Limits		Proc Save/Delete Procedure
Position													
	Freq Channel Information												
	Parm Test Parameters												
	Seqn Order of Tests												
Select	Spec Pass Fail Limits												
	Proc Save/Delete Procedure												
<p>The Pass Fail Limits screen is now present on your CRT.</p>	<p>3 Position cursor and select Spec # field.</p> <p>(Disregard this number)</p> 												

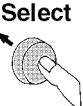

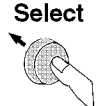
SPEC1

Continue on next page

<p>4 Scroll to and select desired Spec #.</p>	<p>5 Position cursor and select Lower limit field.</p>
<p>Scroll  Select </p> <p>(This Spec # is an example)</p> <p>6 FCC TX output p -1.000000 1.</p> <p></p>	<p>Position  Select </p> <p>6 FCC TX output p -1.000000 1.</p> <p></p>
<p>6 Use DATA keys to enter new value, then select it.</p>	<p>7 Position cursor and select Upper Limit field.</p>
<p>Enter  Select </p> <p>6 FCC TX output p -0.500000 1.</p> <p>(enter your desired value)</p>	<p>Position  Select </p> <p>C TX output power adjustme .500000 1.000000 dB</p> <p></p>
<p>8 Use DATA keys to enter new value, then select it.</p>	<p>9 Position cursor and select Check field.</p>
<p>Enter  Select </p> <p>C TX output power adjustme .500000 0.500000 dB</p> <p>(enter your desired value)</p>	<p>Position  Select </p> <p>Both</p> <p></p>

SPEC2

Continue on next page

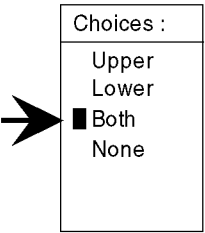
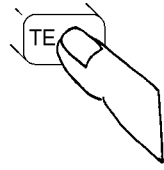
10 <i>Position cursor and select Both .</i>		11 <i>Press TESTS to return to the TESTS screen.</i>		
Position 		Select 		







SPEC3

Changing the Test Parameters

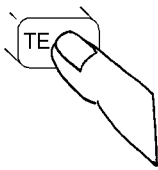
The software uses parameters to optimize the test environment and conditions for your testing situation. Many of the test parameters are determined by examining your test needs. The software comes with default settings for test parameters. Review the defaults for your particular needs. See "**Test Parameter Descriptions**" in **chapter 4 on page 103** for descriptions of each test parameter. For information on saving customized test parameters, see "**Saving a Test Procedure**" on **page 47**.











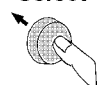

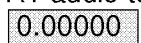

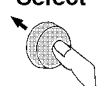

The following describes how you can change test parameters through the Test Parameter screen to optimize your testing conditions.

How to Change the Test Environment and Conditions

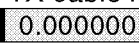
<p>1 Press TESTS to display the TESTS screen.</p>	<p>2 Position cursor and select Parm Test Parameters.</p>														
<p>If you are in IBASIC, press SHIFT, CANCEL before pressing TESTS.</p> 	<table border="1"><tr><td>Position</td><td></td></tr><tr><td></td><td>Freq Channel Information</td></tr><tr><td></td><td>Parm Test Parameters</td></tr><tr><td></td><td>Seqn Order of Tests</td></tr><tr><td></td><td>Spec Pass Fail Limits</td></tr><tr><td>Select</td><td></td></tr><tr><td></td><td>Proc Save/Delete Procedure</td></tr></table>	Position			Freq Channel Information		Parm Test Parameters		Seqn Order of Tests		Spec Pass Fail Limits	Select			Proc Save/Delete Procedure
Position															
	Freq Channel Information														
	Parm Test Parameters														
	Seqn Order of Tests														
	Spec Pass Fail Limits														
Select															
	Proc Save/Delete Procedure														

PARM1

Continue on next page

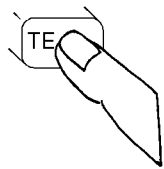
<p>The Tests Parameters screen is now present on your CRT.</p>	<p>3 Position cursor and select Parm # field.</p> <p>Position  Select </p> <p>(Entries on your display may be different)</p> <p> 1 RT audio test to  0.00000</p> <p></p>
<p>4 Scroll to and select Parm # to be changed.</p> <p>Scroll  Select </p> <p>(This parameter number and description are examples)</p> <p> 15 TX cable loss </p>	<p>5 Position cursor and select Value field.</p> <p>Position  Select </p> <p> 15 TX cable loss  0.000000 </p>
<p>6 Use DATA keys to enter new value, then select it.</p> <p>Enter  Select </p> <p> 15 TX cable loss  1.000000 </p>	<p>7 Press TESTS to return to the TESTS screen.</p> <p></p>











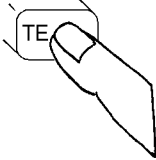
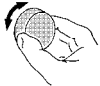
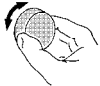
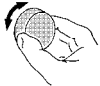



PAPM2

Saving a Test Procedure

A Test Procedure is a collection of channel information, test parameters, testing order, and pass/fail limits saved in a file that customizes the test software to a specific application. You may save the file to a memory card or disk. When you save a procedure you will be saving channel information, test parameters, pass/fail limits, and testing order, plus a library that contains the names of all test parameters, pass/fail limits, and tests that are resident in the software. The library file comes from the software and cannot be modified. The library file will be automatically saved on the card or disk that is being used to store the new test procedure.

The following example shows how to save a new procedure to a memory card. For more information concerning procedures, see **"Procedures" in chapter 5 on page 198**.

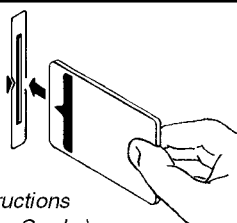

How to Save a Test Procedure



<p>1 Press TESTS to display the TESTS screen.</p> <p>If you are in IBASIC, press SHIFT, CANCEL before pressing TESTS.</p> 	<p>2 Position cursor and select Proc Save/Delete Procedure.</p> <table border="1"> <tr> <td>Position</td> <td></td> </tr> <tr> <td></td> <td>Freq Channel Information</td> </tr> <tr> <td></td> <td>Parm Test Parameters</td> </tr> <tr> <td></td> <td>Seqn Order of Tests</td> </tr> <tr> <td></td> <td>Spec Pass Fail Limits</td> </tr> <tr> <td>Select</td> <td>Proc Save/Delete Procedure</td> </tr> </table>	Position			Freq Channel Information		Parm Test Parameters		Seqn Order of Tests		Spec Pass Fail Limits	Select	Proc Save/Delete Procedure
Position													
	Freq Channel Information												
	Parm Test Parameters												
	Seqn Order of Tests												
	Spec Pass Fail Limits												
Select	Proc Save/Delete Procedure												
<p>The Save/Delete Procedure screen is now present on your CRT.</p>	<p>3 Position cursor and select Select Procedure Location.</p> <table border="1"> <tr> <td>Position</td> <td></td> </tr> <tr> <td></td> <td>Select Procedure Location:</td> </tr> <tr> <td></td> <td></td> </tr> <tr> <td>Select</td> <td></td> </tr> </table>	Position			Select Procedure Location:			Select					
Position													
	Select Procedure Location:												
													
Select													
<p>4 Position cursor and select Card.</p> <table border="1"> <tr> <td>Position</td> <td></td> </tr> <tr> <td></td> <td>Choices :</td> </tr> <tr> <td></td> <td>■ Card</td> </tr> <tr> <td></td> <td>RAM</td> </tr> <tr> <td></td> <td>Disk</td> </tr> </table> <p>(You can also save procedures to an internal RAM disk or external disk drive. See Chapter 5-Disks.)</p>	Position			Choices :		■ Card		RAM		Disk	<p>5 Insert an initialized SRAM memory card.</p>  <p>(For detailed memory card initialization instructions see Chapter 5-Memory Cards.)</p>		
Position													
	Choices :												
	■ Card												
	RAM												
	Disk												

PROCMA11

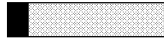

Continue on next page

7 *Position cursor and select*
Enter Procedure Filename:.

Position

Select



Enter Procedure Filename:





8 *Select characters to name the procedure, then select Done.*

Position

Select



Choices :
 Done
 Position
 Over/Ins
 Delete
 Del End
 Bk space
 A
 B
 C

9 *Position cursor and select*
Enter Description for new

Position

Select



Enter Description for new ...





10 *Select characters for the description, then select Done.*

Position

Select



Choices :
 Done
 Position
 Over/Ins
 Delete
 Del End
 Bk space
 A
 B
 C

11 *Position cursor at Procedure Library: and select Current.*

Position

Select













Procedure Library:
Current / [NO LIB]

 (The underline indicates which option is selected. Pressing knob changes the selection.)

12 *Position cursor and select Code Location:.*

Code Location:
 Card

PROCMA2

Continue on next page

12 Position cursor at Card and select it.	13 Position cursor at Save Proc and select it.								
<table border="1"><tr><td>Position </td><td>Choices : ■ Card RAM Disk</td></tr><tr><td>Select </td><td></td></tr></table>	Position 	Choices : ■ Card RAM Disk	Select 		<table border="1"><tr><td>Position </td><td>■ Save Proc 2 Del Proc 3 Init Card 4 Help 5 Main Menu</td></tr><tr><td>Select </td><td></td></tr></table>	Position 	■ Save Proc 2 Del Proc 3 Init Card 4 Help 5 Main Menu	Select 	
Position 	Choices : ■ Card RAM Disk								
Select 									
Position 	■ Save Proc 2 Del Proc 3 Init Card 4 Help 5 Main Menu								
Select 									

14 Press **TESTS** to return to the **TESTS (Main Tests)** screen.

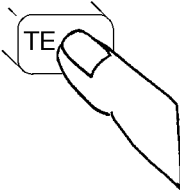

15 To run the saved procedure, follow the instructions below.

- 1) Insert the RAM card with your saved procedure.
- 2) On the **TESTS (Main Menu)** screen, a) position cursor and select **Select Procedure Location:**, then select **Card**, b) position cursor and select **Select Procedure Filename:**, then select your saved file name.
- 3) Remove your RAM card and insert the original HP 11807A ROM memory card.
- 4) Press **Run Test**.

The original card contains the full program needed to run your procedure.

PR00MA3a

Changing Test Execution Conditions

Test Execution Conditions define where and when test output occurs. You may decide to:

- Display output on CRT only, or display on CRT and print hardcopy (**Output Results To**).

NOTE:

If printing test results is desired, after selecting **Printer**, additional steps are necessary to connect and configure the printer. See "**Printing**" in chapter 5 on page 184.

- Display (or print) only measurements that fail, or display (or print) all measurements that pass or fail (**Output Results For**).
- Enter a title for an output heading for the displayed or printed results (**Output Heading**).
- Stop testing when a measurement fails or continue through all of the tests without stopping (**If Unit-Under-Test-Fails**).
- Pause between each measurement, or run through entire test (**Test Procedure Run Mode**).
- Start the program automatically when the Test System is powered on. (**Autostart Test Procedure on Power-up**).

Test Execution Conditions is accessed from the **SETUP TEST SET:** list. To change a default setting, position the cursor to the desired field. Pressing the knob ("selecting") will toggle the underlined selection.

Test Execution Conditions settings are not retained after a power-down/power-up cycle, and will return to their default settings.

How to Change Test Execution Conditions

1 Press **TESTS** to display the **TESTS (Main Menu)** screen.

If you are in IBASIC, press SHIFT, CANCEL before pressing TESTS.

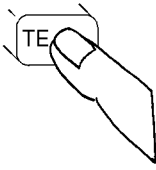

2 Position cursor at **Exec Execution Cond** and select it.

Position		Exec Execution Cond			
		Cnfg External Devices			
		Print Printer Setup			
		IBASIC IBASIC Cntrl			

Select

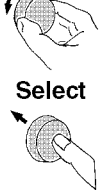

3

Select Printer to output test procedure results to the CRT and a printer.

Select Failures to display only the CRT and printer measurements that fail.

Select Stop to stop a Test Procedure when a failure occurs.

Select Single Step to stop a Test Procedure at the end of each measurement.

TESTS (Execution Conditions)

Output Results To:	Crt/Printer
Output Results For:	All/Failures
Output Heading:	
If Unit-Under-Test Fails:	Continue/Stop
Test Procedure Run Mode:	Continuous/Single Step
Autostart Test Procedure on Power-Up:	Off/On

	1 Run Test
	2 Continue
	4 Help
	5 Main Menu
To Screen	
	RF GEN
	RF ANL
	RF ANL
	SCOPE
	SPEC ANL
	ENCODER
	DECODER
	RADIO INT
	More

TESTEXEa

Printing and Saving Test Results

Printing and saving test results are features of the software which require additional equipment and configuration. See **"Printing" in chapter 5 on page 184** for detailed descriptions and instructions for these features.

**Using the Software/HP 8920B, or HP
8920A FW Below Rev. A.14.00**

NOTE:

The firmware revision A.14.00 in the HP 8920A,D had several enhancements, which are standard in the HP 8920B. This chapter applies to users with:

- **HP 8920A test sets with firmware revision below A.14.00**

The test set's firmware revision is displayed on the top right corner of the configuration screen.

- Press SHIFT CONFIG to display the configuration screen and read the firmware revision.

If you have an HP 8920B or an HP 8920A with firmware revision above A.14.00, refer to [chapter 2, "Using the Software/HP 8920B, or HP 8920A FW Above Rev. A.14.00," on page 21](#). Contact Hewlett-Packard at 1-800-922-8920 for details on upgrading your firmware if desired.

The HP 11807A software can be run on the factory default settings or customized to your individual needs and the specific requirements. This chapter provides detailed information on how to load, run, and customize the software.

Testing Overview

Pressing TESTS will display what is called the **TESTS** screen. To begin testing, you must first load the software and make connections. From this screen you have the option to:

Begin running tests:

- The factory default settings are acceptable for your application or
- The software has already been customized and saved to a memory card

Customize the software:

- Decide which tests you desire to run (**Edit Seqn**)
 - you may want to run all, some, or just one of the tests.
- Specify which channels to test (**Edit Freq**)
 - you may want to test one, some, or all of the channels on your radio.
- Change the pass/fail limits for specific measurements (**Edit Spec**)
 - you may want the pass/fail limits to have tighter or looser specifications than the default settings.
- Change the test environment and conditions (**Edit Parm**)
 - decide output format.
 - enter specific information about radio equipment and/or environment.
- Save any or all of the above customized changes to a memory card (**Proc Mngr**)

Set Up Test Set:

- Print test results or certain screens.
- Decide when and where test results are displayed (**Edit Cnfg**)

To Run Tests

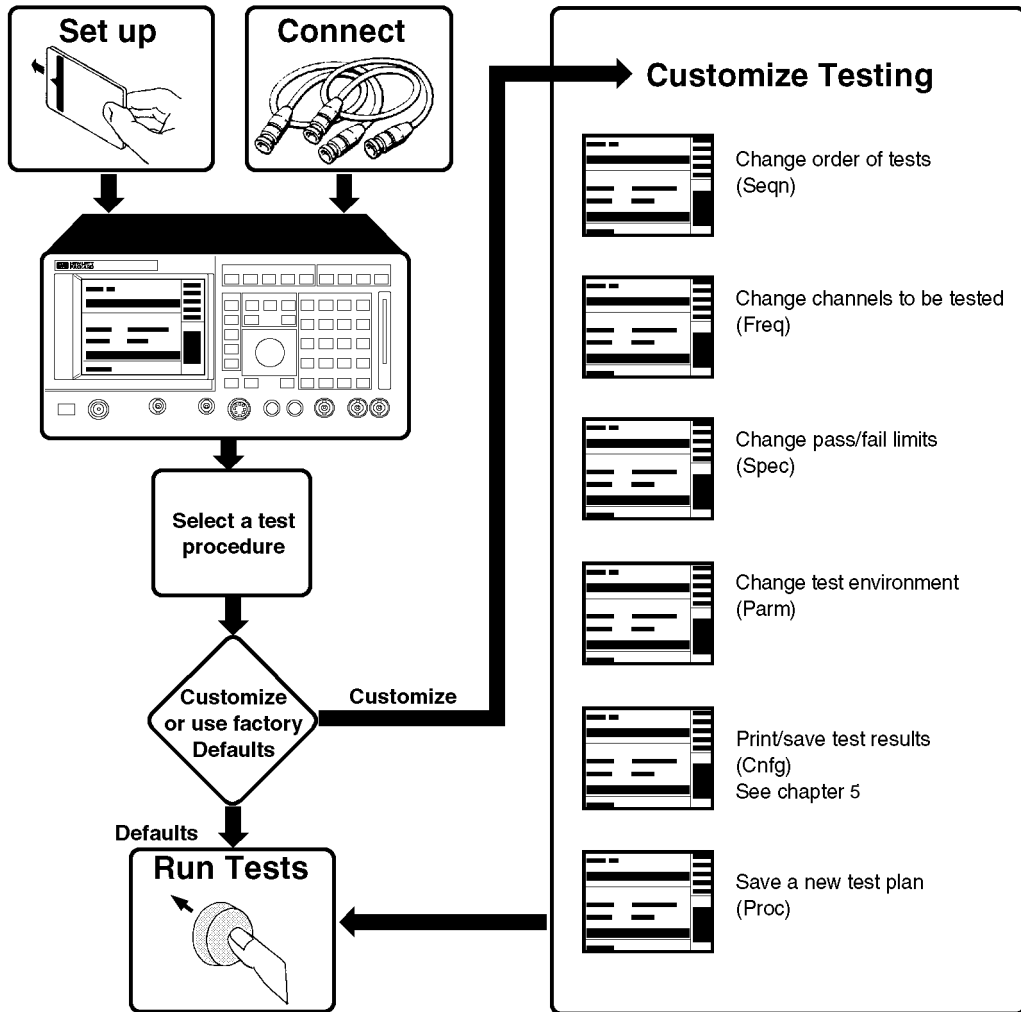

OVREVIEWS

Setting Up the Test Set and Making Connections

Before you begin testing, you must set up the test set and make the appropriate hardware connections.

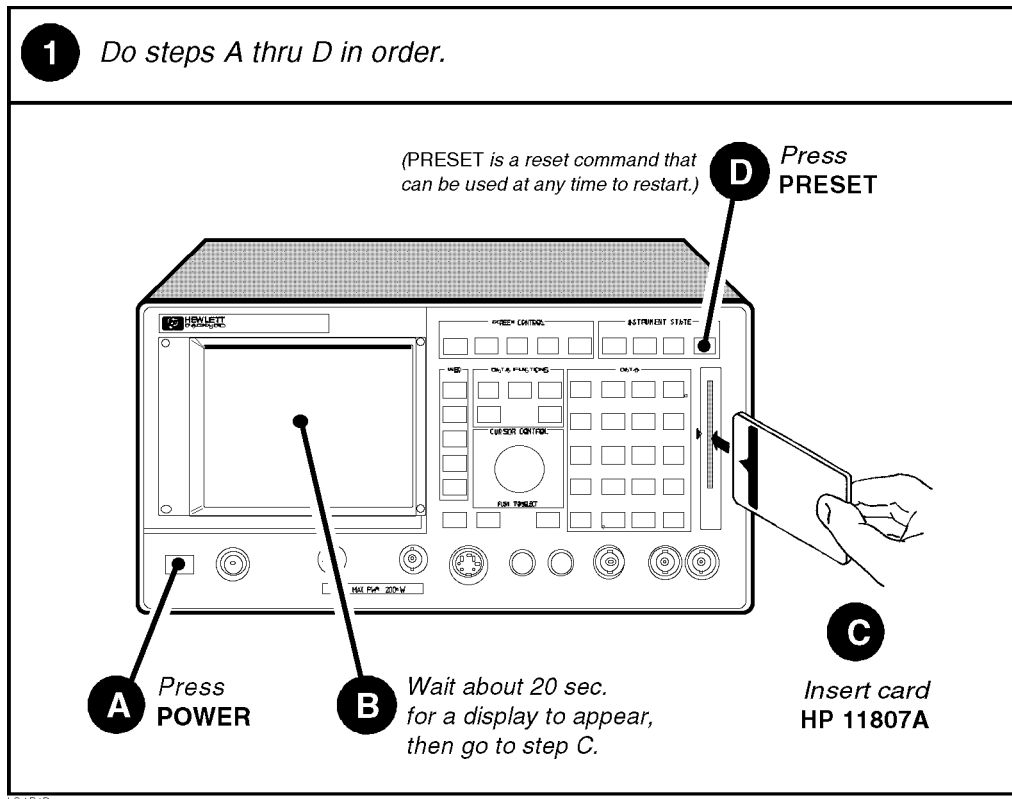

LOAD1B

Making a Connection

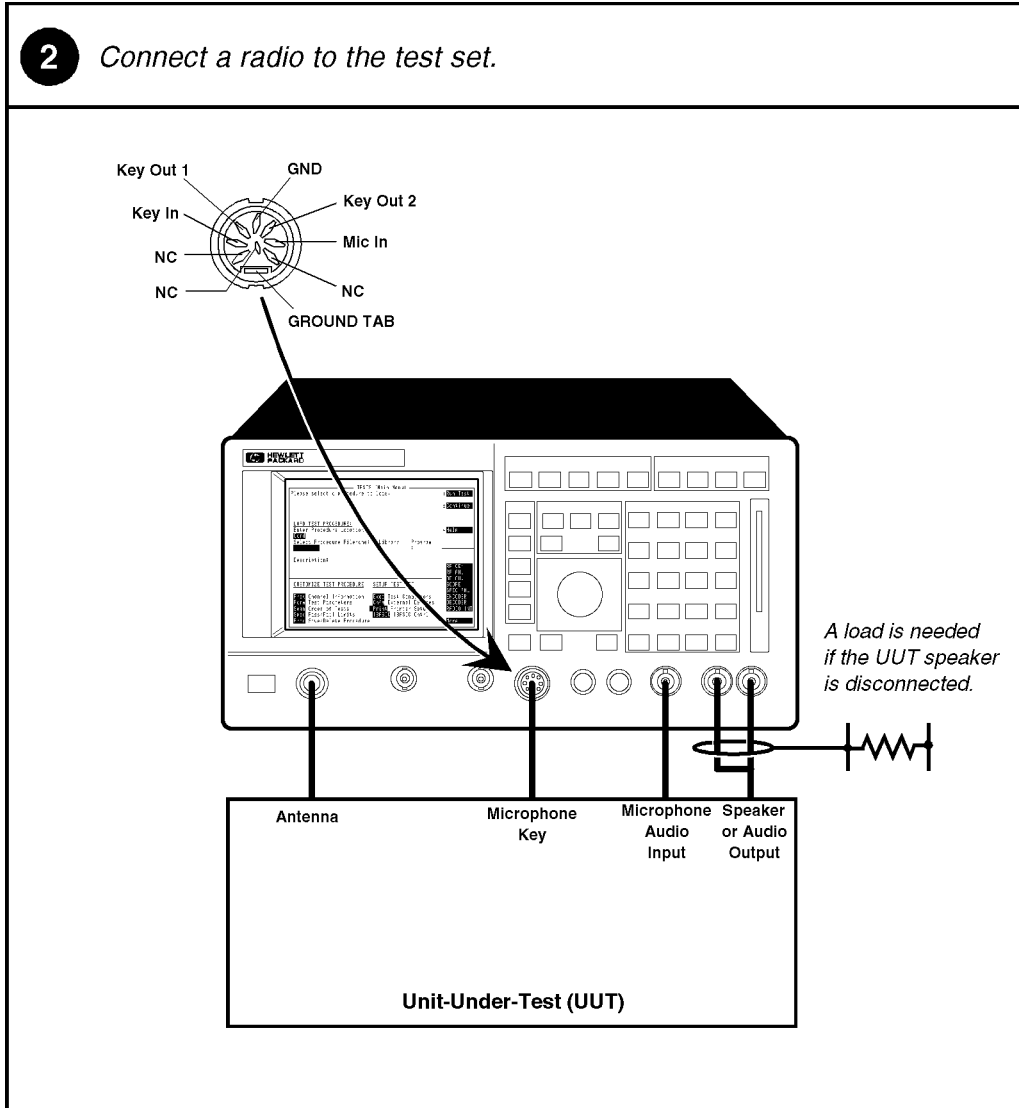

CONNECTB

Selecting a Test Procedure











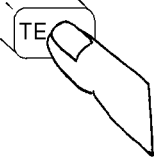

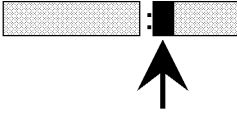
To load the software, you must first select the location to load from (in this case, it will be **Card**) and a procedure filename. Your card comes pre-programmed with at least one procedure. The actual software program does not get loaded into the test set's memory until k1 (**Run Test**) is selected. It will take approximately 2 minutes to load the software in an HP 8920A,D.

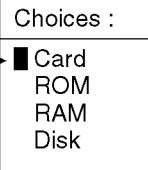
The software memory card can be removed after the program is loaded into the test set's memory. The program will remain in memory after a power-down/power-up cycle, unless it is manually deleted or a new program is loaded.

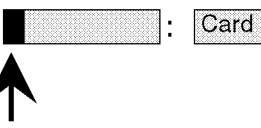
When tests begin to run, they are executed in the order in which they were entered into the Test Procedure.

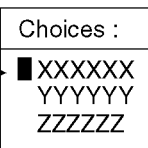
Pressing CANCEL will pause the current test (press k2 to continue the test.)

Selecting A Test Procedure

<p>1 Press TESTS to display the TESTS screen.</p>	<p>2 Position cursor at Location and select it.</p>
<p>If you are in IBASIC, press SHIFT, CANCEL before pressing TESTS.</p> 	<p>Position</p>  <p>Procedure: Location</p>  
<p>3 Position cursor at Card and select it.</p>	<p>4 Position cursor at Procedure and select it.</p>
<p>Position</p>  <p>Select</p>  	<p>Position</p>  <p>Procedure: Location</p>  
<p>5 Position cursor at the desired Procedure and select it.</p>	<p>6 Position cursor at Run Test and select it.</p>
<p>Position</p>  <p>Select</p>  	<p>Position</p>  <p>Select</p>   <p>Procedures may take 2-3 minutes to load.</p>

PROCED1B

Customizing Testing

Because of the diversity of individual testing needs, the software has been designed so that changes may be easily made from the test set's front panel. You may store these changes on an SRAM card so that you may skip these steps in the future. See "[Saving a Test Procedure Using the Procedure Manager](#)" on page 79.

You may customize your software at any time. Because your needs change, the software allows changes to its default settings when you need to make them and in any order that you choose. For example, tests may be inserted or deleted, and later after running the tests you can change the pass/fail limits or decide to test different channels.

Most testing customization is accomplished through the test set's Test Function screens. These Test Function screens are accessed from the main **TESTS** screen as shown in the following figure. All Test Functions are explained in this chapter by function.

NOTE:

Edit Cnfg and IBASIC will not be explained in this customizing section.

- Edit Cnfg is used when setting up printers and external disk drives which is explained in "[Disks](#)" in chapter 5, on page 169 and "[Printing](#)" in chapter 5, on page 184.
- IBASIC is used when writing your own programs and is not explained in this manual. If you need to write your own IBASIC programs you may acquire the following manuals:
 - HP 8920A,D
 - *HP Instrument Basic User's Handbook* HP part number E2083- 90000.
 - *HP 8920A Programming Manual* HP part number 08920-90220.
 - HP 8920B
 - *HP Instrument Basic User's Handbook Version 2.0* HP part number E2083-90005.
 - *HP 8920B Programming Manual* HP part number 08920-90222.

Beginning Software Customization

All software customization begins by accessing the **TESTS** screen first and then selecting the **Test Function** which will open the **Choices** menu. To access the **TESTS** screen, press TESTS on the front panel of the test set.

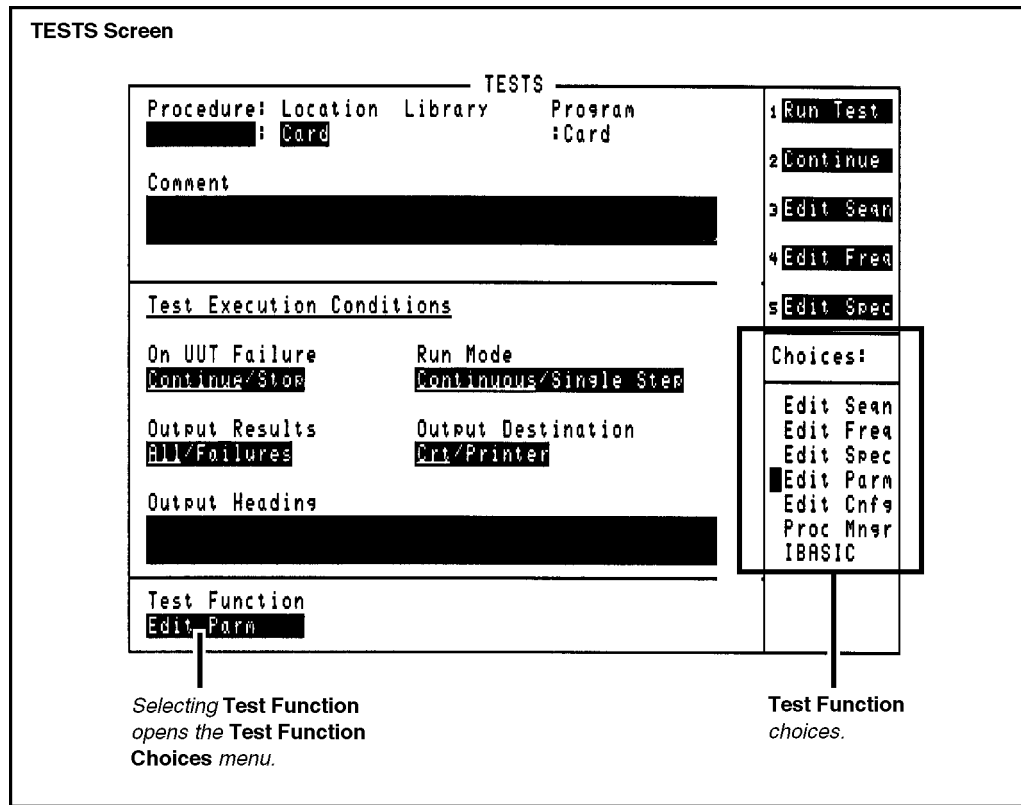

CUSTOM18

Changing the Order of Tests (Edit Sequence)











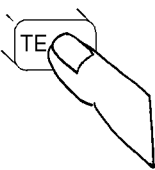

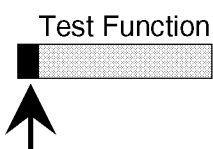
You may define a test sequence to include all, some, or just one of the tests available. When the first test is finished, the next will run. The test sequence will remain in the Test System's battery backed-up memory until another test sequence is loaded or set up. For information on saving a customized test sequence, see "[Customizing Testing](#)" on page 62.

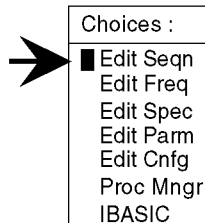
Creation of a test sequence is accomplished by inserting or deleting tests from the list of tests that come with the HP 11807A software package. See [chapter 4, "Test, Parameter, and Pass/Fail Limit Descriptions,"](#) on page 85, for test descriptions.

The **All Chans?** field allows the user to decide to run the test on all channels entered in the frequency table, or just the channels which are selected as **Prime** in the **Edit Freq** screen. This feature allows the user the flexibility to use channels that are selected as **Prime** in all the tests in the sequence, and those selected as non-prime in a subset of tests (those with a **Yes** response in **All Chans**). For more information, see "[Specifying Channel Information \(Edit Frequency\)](#)" on page 68.













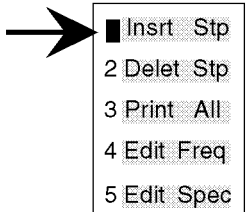





The following describes how to create a new test sequence and enter a response to **All Chans**.

How to Change a Sequence of Tests

<p>1 Press TESTS to display the TESTS screen.</p>	<p>2 Position cursor at Test Function and select it.</p>
<p>If you are in IBASIC, press SHIFT, CANCEL before pressing TESTS.</p> 	<p>Position</p>  <p>Select</p>  
<p>3 Position cursor at Edit Seqn and select it.</p>	<p>4 Position cursor at Step # field and select it.</p>
<p>Position</p>  <p>Select</p>   <p>Choices :</p> <ul style="list-style-type: none"> █ Edit Seqn Edit Freq Edit Spec Edit Parm Edit Cnfg Proc Mngr IBASIC 	<p>Position</p>  <p>Select</p>  <p><i>Example</i></p>  <p>"#"</p> <p>"TEST_#"</p> <p>"Test name"</p>
<p>5 By rotating knob, highlight the Step # which precedes the insertion point of the new test that you are adding, then select it.</p>	
<p>Rotate</p>  <p>Select</p> 	<p><i>For example, select step 7 if you want to insert the new test as step 8.</i></p>  <p>"7"</p> <p>"TEST_#"</p> <p>"Test name"</p>  <p>"8"</p> <p>"New test"</p>

SEQ1B

Continue on next page

<p>6 Position cursor at Insrt Stp and select it.</p>	<p>7 Position cursor back at Step # field and select it.</p>
<p>Position</p>  <p>Select</p>  	<p>Position</p>  <p>Select</p>  
<p>8 Highlight Step # of the newly inserted test, then select it.</p>	<p>9 Position cursor at Test name field and select it.</p>
<p>Position</p>  <p>Select</p>  <p><i>This is the test that you selected at step 5.</i></p> 	<p>Position</p>  <p>Select</p>  
<p>10 Rotate knob until desired Test Name appears, then select it</p>	<p>11 Position cursor at All Chans? field and select Yes or No.</p>
<p>Rotate</p>  <p>Select</p>  	<p>Position</p>  <p>Select</p>   <p><i>(Press the knob to change the selection.)</i></p>

8EQ2B

Continue on next page

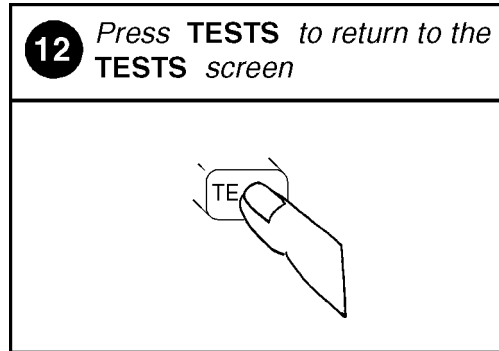

Specifying Channel Information (Edit Frequency)

For each channel that you wish to specify, you must enter the following information into the **Edit Frequency** screen:

- RX Freq (MHz)
 - Enter the receive frequency of your radio in (MHz).
- TX Freq (MHz)
 - Enter the transmit frequency of your radio in (MHz).

NOTE: Enter a **-1** in the RX or TX test frequency fields to have all subsequent frequencies ignored when testing is started.

- **Test?** (yes/no) specifies whether you want to test the UUT at this channel. If set to "No" then the UUT will not be tested at that channel, but you may retain the channel information in the table for later use. If set to "Yes" then the channel will be used as defined by settings of **Prime?** and **All Chans?** fields.
- **Prime?** (yes/no) specifies which channels are "prime". Select "Yes" if you want to test the UUT at this channel on all the tests in the procedure. Select **No** if you want to test the UUT at this channel on just a subset of tests, which are designated by selecting **Yes** in the **All Chans** field of the **Edit Seqn** screen. See **All Chans?** in "[Changing the Order of Tests \(Edit Sequence\)](#)" on page 64 for more information.

For information on saving the frequency table, see "[Saving a Test Procedure Using the Procedure Manager](#)" on page 79.

The **All Chans** field in the **Edit Seqn** screen interacts closely with the **Prime?** field on the **Edit Freq** screen. When the software runs, it begins by retrieving the first channel entered into the **Edit Freq** screen. It then checks the response in the **Test?** field to determine if the UUT should be tested at that channel at this time. If there is a **No** response in the **Test?** field, the software will go to the next channel in the table. If there is a **Yes** response in the **Test?** field, the software will check if the channel is **Prime**.

A **Yes** response in the **Prime?** field indicates to test the UUT at that channel on the entire sequence of tests in the procedure. A **No** response in the **Prime?** field indicates to test the UUT at that channel on a subset of tests in the procedure. The subset of tests is determined by a **Yes** response in the **All Chans?** field. Therefore, tests with a **No** response in the **All Chans?** field will be run on *prime* channels only.

Below is an example of how the software would run if you had a procedure set up as follows:

Table 4

Chan #	Test?	Prime?
Chan 01	Yes	Yes
Chan 02	Yes	No
Chan 03	No	No

Table 5

Test Number	All Chan? Setting
Test 01	No
Test 02	Yes
Test 03	Yes
Test 04	No

The result would be:











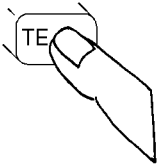

- Chan 01 is used in Test 01, Test 02, Test 03, and Test 04.
- Chan 02 is used in 02, and Test 03 only.
- Chan 03 is not used.

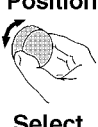
The following **table 6** shows how to properly configure these settings according to your testing needs.

Table 6

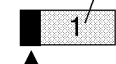
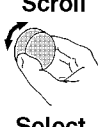

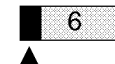
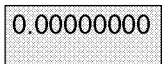
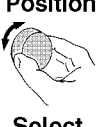

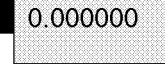





Testing Need	Necessary Field Settings		
	Test?	Prime?	All Chan?
Test channel on all tests in sequence	Yes	Yes	Don't Care
Test channel on a subset of tests in sequence	Yes	No	Yes on tests you want included in the testing subset
Do not test this channel now, but retain information for later use	No	Don't Care	Don't Care

How to Specify Channel Information

<p>1 Press TESTS to display the TESTS screen.</p> <p><i>IF you are in IBASIC, press SHIFT, CANCEL before pressing TESTS.</i></p> 	<p>2 Position cursor at Test Function and select it.</p> <p>Position</p>  <p>Select</p>  <p>Test Function</p> 
<p>3 Position cursor at Edit Freq and select it.</p> <p>Position</p>  <p>Select</p>  <p>Choices :</p> <ul style="list-style-type: none"> ■ Edit Seqn ■ Edit Freq ■ Edit Spec ■ Edit Parm ■ Edit Cnfg ■ Proc Mngr ■ IBASIC 	<p>4 Position cursor at Chan # field and select it.</p> <p>Position</p>  <p>Select</p>  <p>(Disregard this number.)</p> 
<p>5 Scroll to the desired Chan # and select it.</p> <p>Scroll</p>  <p>Select</p>  <p>(This Chan # is an example.)</p>  	<p>6 Position cursor and select RX Freq (MHz) field.</p> <p>Position</p>  <p>Select</p>  

FREQ1B

Continue on next page

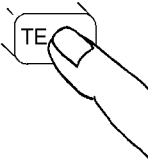
<p>7 Use DATA keys to enter new RX Freq, then select it.</p>	<p>8 Position cursor at TX Freq (MHz) field and select it.</p>
<p>Enter</p>  <p>Select</p>  <p>6 "New #" (Enter your desired RX Freq)</p>	<p>Position</p>  <p>Select</p>  <p>##### 0.000000 (Arrow pointing to the field)</p>
<p>9 Use DATA keys to enter new TX Freq, then select it.</p>	<p>10 Position cursor at Test? field and select Yes or No.</p>
<p>Enter</p>  <p>Select</p>  <p>##### "New #" (Enter your desired TX Freq)</p>	<p>Position</p>  <p>Select</p>  <p>Yes/No (Press knob to change the selection.)</p>
<p>11 Position cursor at Prime? field and select Yes or No.</p>	<p>12 Press TESTS to return to the TESTS screen.</p>
<p>Position</p>  <p>Select</p>  <p>Yes/No (Press knob to change the selection.)</p>	







FREQ2b

Changing Pass/Fail Limits (Edit Specifications)

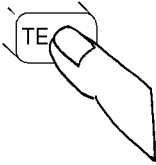

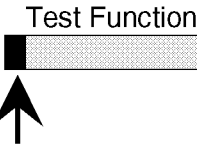



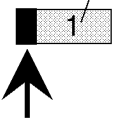



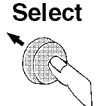

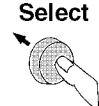
Specifications are values that set pass/fail limits for tests. Default values are available in the test software. These default values may be changed to suit your particular requirements.

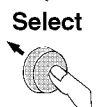
The following describes how to change the pass/fail (upper and lower) limits in the HP 8920A,D **Edit Specification** screen. See "**Pass/Fail Limit Descriptions**" in chapter 4, on page 132 for descriptions for each specification. For information on saving customized specifications, see "**Saving a Test Procedure Using the Procedure Manager**" on page 79.

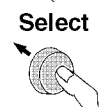
How to Change Pass/Fail Limits

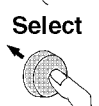

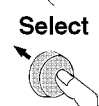

<p>1 Press TESTS to display the TESTS screen.</p> <p><i>IF you are in IBASIC, press SHIFT, CANCEL before pressing TESTS.</i></p> 	<p>2 Position cursor at Test Function and select it.</p> <p>Position</p>  <p>Select</p>  <p>Test Function</p> 
<p>3 Position cursor at Edit Spec and select it.</p> <p>Position</p>  <p>Select</p>  <p>Choices :</p> <ul style="list-style-type: none"> Edit Seqn Edit Freq █ Edit Spec Edit Parm Edit Cnfg Proc Mngr IBASIC 	<p>4 Position cursor at Spec # field and select it.</p> <p>Position</p>  <p>Select</p>  <p>(Disregard this number.)</p> 

Continue on next page

<p>5 Scroll to the desired Spec # and select it.</p>	<p>6 Position cursor at Lower limit field and select it.</p>
<p>Position</p>  <p>(This Spec # is an example.)</p> <p>Select</p>  <p>6 FCC TX output p -1.000000 1.</p> 	<p>Position</p>  <p>6 FCC TX output p -1.000000 1.</p> <p>Select</p>  
<p>7 Use DATA keys to enter new value, then select it.</p>	<p>8 Position cursor at Upper Limit field and select it.</p>
<p>Position</p>  <p>6 FCC TX output p -0.500000 1.</p> <p>Select</p>  <p>(Enter your desired value.)</p>	<p>Position</p>  <p>C TX output power adjustme .500000 1.000000 dB</p> <p>Select</p>  
<p>9 Use DATA keys to enter new value, then select it.</p>	<p>10 Position cursor at Check field and select it.</p>
<p>Position</p>  <p>C TX output power adjustme .500000 0.500000 dB</p> <p>Select</p>  <p>(Enter your desired value.)</p>	<p>Position</p>  <p>Both</p> <p>Select</p>  

SPEC2B

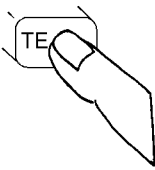
Continue on next page

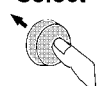
11 <i>Position cursor at Both and select it.</i>		12 <i>Press TESTS to return to the TESTS screen.</i>						
Position 		Position 						
Select 	<table border="1"><tr><td>Choices :</td></tr><tr><td>Upper</td></tr><tr><td>Lower</td></tr><tr><td><input checked="" type="checkbox"/> Both</td></tr><tr><td>None</td></tr></table>	Choices :	Upper	Lower	<input checked="" type="checkbox"/> Both	None	Select 	
Choices :								
Upper								
Lower								
<input checked="" type="checkbox"/> Both								
None								

SPEC3B

Changing the Test Environment and Conditions (Edit Parameters)

The software uses parameters to optimize the test environment and conditions for your testing situation. Many of the parameters are determined by examining your test needs. Other parameters are determined by performing measurements to calibrate items in your system. Examples of parameters include cable losses, rated system deviation, and the audio test tone frequency your system requires. The HP 11807A software comes with default settings for parameters. The defaults should be reviewed for your particular needs. See "[Test Parameter Descriptions](#)" in [chapter 4, on page 103](#) for descriptions and default values for each parameter. For information on saving customized parameters, see "[Saving a Test Procedure Using the Procedure Manager](#)" on page 79.





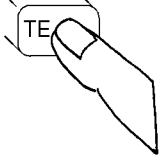
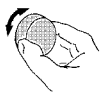
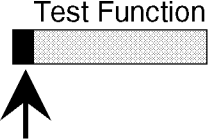
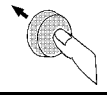
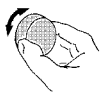
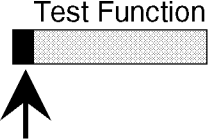
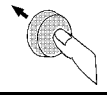
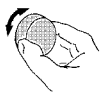
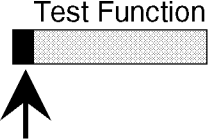
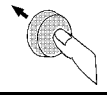

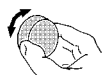
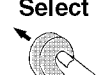
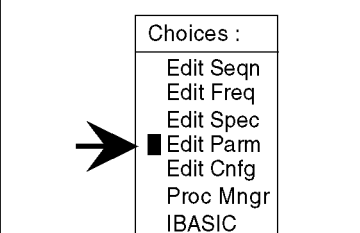
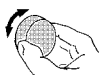

The following describes how you can change parameters through the Edit Parameter screen to optimize your testing conditions.

How to Change the Test Environment and Conditions

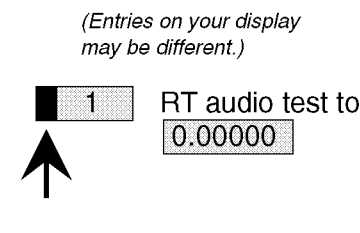
1 Press TESTS to display the TESTS screen.	2 Position cursor at Test Function and select it.				
<p><i>If you are in IBASIC, press SHIFT, CANCEL before pressing TESTS.</i></p> 	<table border="1"><tr><td data-bbox="857 1098 979 1213">Position </td><td data-bbox="979 1098 1346 1213">Test Function </td></tr><tr><td data-bbox="857 1213 979 1339">Select </td><td data-bbox="979 1213 1346 1339"></td></tr></table>	Position 	Test Function 	Select 	
Position 	Test Function 				
Select 					

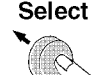
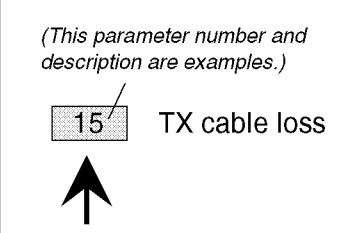
PARM1B

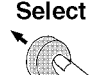
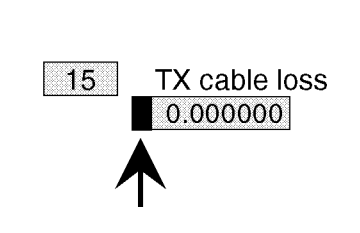
Continue on next page

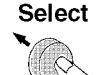
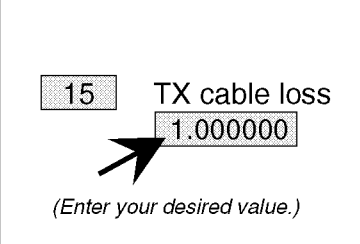
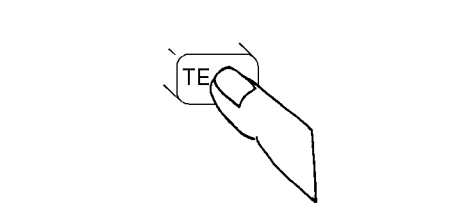
<p>3 Position cursor at Edit Parm and select it.</p>	<p>4 Position cursor at Parm # field and select it.</p>
<p>Position</p>  <p>Select</p>  	<p>Position</p>  <p>Select</p>  <p>(Entries on your display may be different.)</p> 
<p>5 Scroll to Parm # to be changed and select it</p>	<p>6 Position cursor at Value field and select it.</p>
<p>Scroll</p>  <p>Select</p>  <p>(This parameter number and description are examples.)</p> 	<p>Position</p>  <p>Select</p>  
<p>7 Use DATA keys to enter new value, and select it.</p>	<p>8 Press TESTS to return to the TESTS screen.</p>
<p>Enter</p>  <p>Select</p>   <p>(Enter your desired value.)</p>	









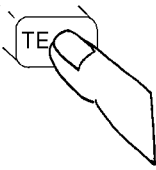
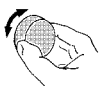
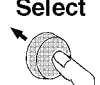
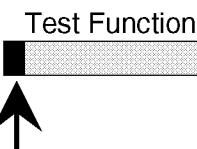

PARM2B

Saving a Test Procedure Using the Procedure Manager

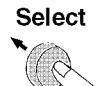
A Test Procedure is a collection of pass/fail limits (specifications), the test environment and conditions (parameters), and a TEST sequence, saved in a file that customizes the test software to a specific application. You may save the file to a memory card or disk. When you save a Procedure you will be saving parameters, specifications, and a test sequence, plus a library that contains the names of all parameters, specifications, and tests that are resident in the HP 11807A software. The library file comes from the HP 11807A software and cannot be modified. The library file will be automatically saved on the card or disk that is being used to store the new test procedure.

The following example shows how to save a new procedure to a memory card. For more information concerning procedures, see **"Procedures" in chapter 5, on page 198.**

How to Save a Test Procedure

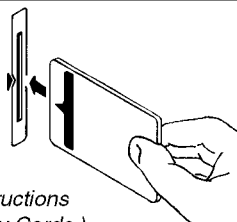
<p>1 Press TESTS to display the TESTS screen.</p>	<p>2 Position cursor at Test Function and select it.</p>										
<p>If you are in IBASIC, press SHIFT, CANCEL before pressing TESTS.</p> 	<p>Position</p>  <p>Select</p>  										
<p>3 Position cursor at Proc Mngr and select it.</p>	<p>4 Position cursor at Procedure field and select it.</p>										
<p>Position</p>  <p>Select</p>  <table border="1" data-bbox="535 934 682 1155"> <tr><td>Choices :</td></tr> <tr><td>Edit Seqn</td></tr> <tr><td>Edit Freq</td></tr> <tr><td>Edit Spec</td></tr> <tr><td>Edit Parm</td></tr> <tr><td>Edit Cnfg</td></tr> <tr><td>Proc Mngr</td></tr> <tr><td>IBASIC</td></tr> </table> 	Choices :	Edit Seqn	Edit Freq	Edit Spec	Edit Parm	Edit Cnfg	Proc Mngr	IBASIC	<p>Position</p>  <p>Select</p>  <p>Procedure: Location</p>  		
Choices :											
Edit Seqn											
Edit Freq											
Edit Spec											
Edit Parm											
Edit Cnfg											
Proc Mngr											
IBASIC											
<p>5 Select characters to name the Procedure, then select Done.</p>	<p>6 Insert an initialized SRAM memory card.</p>										
<p>Position</p>  <p>Select</p>  <table border="1" data-bbox="535 1297 682 1512"> <tr><td>Choices :</td></tr> <tr><td>Done</td></tr> <tr><td>Position</td></tr> <tr><td>Over/Ins</td></tr> <tr><td>Delete</td></tr> <tr><td>Del End</td></tr> <tr><td>Bk space</td></tr> <tr><td>A</td></tr> <tr><td>B</td></tr> <tr><td>C</td></tr> </table>  	Choices :	Done	Position	Over/Ins	Delete	Del End	Bk space	A	B	C	 <p>(For detailed memory card initialization instructions see chapter 5 -Memory Cards.)</p>
Choices :											
Done											
Position											
Over/Ins											
Delete											
Del End											
Bk space											
A											
B											
C											

PROCMA1B

Continue on next page

7 Position cursor at **Location** and select it.

8 Position cursor at **Card** and select it.

9 Position cursor at **Comment** and select it.





10 Select characters for the **Comment**, then select **Done**.

11 Position cursor at **Library** for new p.... , and select **Current**.

12 Position cursor at **Program** location for and select it.

Continue on next page

PROCMA2B

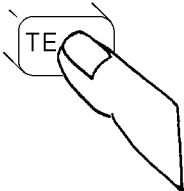
<p>13 Position cursor at Card and select it.</p>	<p>14 Position cursor at Action and select Make Procedure.</p>
<p>Position</p>  <p>Select</p>  <p>Choices :</p> <ul style="list-style-type: none">■ CardRAMDisk	<p>Position</p>  <p>Action</p> <ul style="list-style-type: none">■ Make ProcedureDelete Procedure <p>Select</p>  <p>(To make selection, position the cursor in front of Make Procedure, then press the knob.)</p>
<p>15 Press TESTS to return to the TESTS screen.</p>	<p>To run the saved procedure:</p> <ol style="list-style-type: none">1) Load the Procedure.2) Insert the original HP 11807B memory card.3) Press Run Test. <p>The original card contains the full program needed to run your procedure.</p>
	

PROCMA3B

Changing Test Execution Conditions

Test Execution Conditions define how your testing program starts and where and when test output occurs. You may decide to:

- Start the program automatically when the Test System is powered on. (**Autostart**)
- Stop testing when a measurement fails or continue through all of the tests without stopping. (**On UUT Failure**)
- Display (or print) only measurements that fail, or display (or print) all measurements that pass or fail. (**Output Results**)
- Pause between each measurement, or run through the entire test sequence. (**Run Mode**)
- Display output on CRT only, or display on CRT and print hardcopy. (**Output Destination**)

NOTE:

If printing test results is desired, after selecting Printer additional steps are necessary to connect and configure the printer. See "**Printing**" in chapter 5, on page 184.

- Enter a title for an output heading for the displayed or printed results. (**Output Heading**). Select the field with the knob and enter the output heading by selecting the appropriate letters and the select **Done**.

Test Execution Conditions is located on the **TESTS** screen. Press **TESTS** to display them. To change a default setting, position the cursor to the desired field. Pressing the knob ("selecting") will toggle the underlined selection.

Test Execution Conditions settings (except for **Autostart**) are not retained after a power-down/ power-up cycle, and will return to their default settings. They are not stored on the memory card when a test procedure is saved.

How to Change Test Execution Conditions

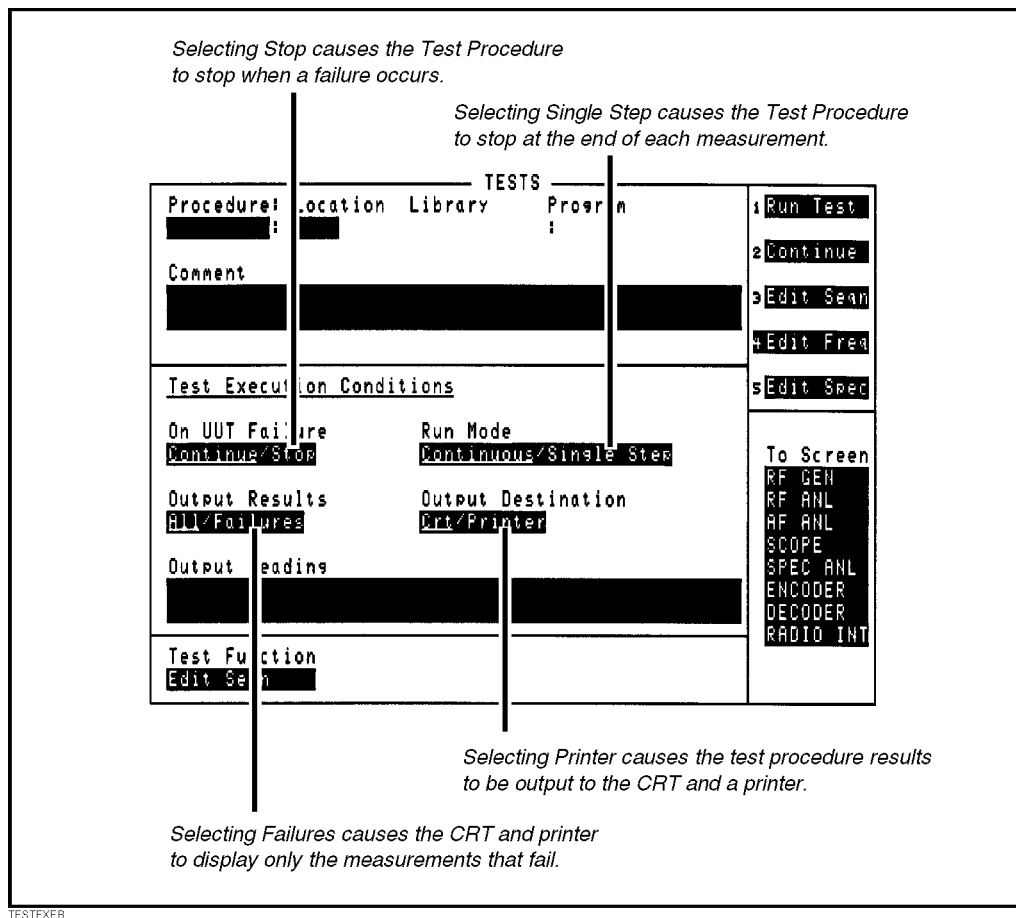

Printing and Saving Test Results

Printing and saving test results are features of the HP 11807A software which require additional equipment and configuration. See **"Printing" in chapter 5, on page 184** for detailed descriptions and instructions for these features.

Test, Parameter, and Pass/Fail Limit Descriptions

Introduction

Tests are a series of measurements, and one or more tests make up a procedure (see [chapter 2, "Using the Software/HP 8920B, or HP 8920A FW Above Rev. A.14.00," on page 21](#)). While you may change the tests that make up a procedure, you may not change the measurements the test will perform. Generally, the order in which the tests are run is not important.

This chapter describes each test and the associated test parameters, pass/fail limits, and external equipment that are required. When you first load a test procedure or create a new test sequence, refer to this section to understand what test parameters and pass/fail limits are required for each test.

Tests are derived from the following industry standard:

- EIA – Electronic Industry Association, AM radio test specifications, RS-382-A

NOTE:

Refer to [chapter 2, "Using the Software/HP 8920B, or HP 8920A FW Above Rev. A.14.00," on page 21](#) in this manual for details about customizing a Test Procedure for testing your FM radio.

TEST_01. TX and RX Stand-by Current Drain

This test measures the power-supply current required by the AM radio while it's in both the transmit and receive modes. While transmitting, current drain is measured without modulation, and while receiving, stand-by current drain is measured after the squelch control is set to maximum.

This test requires that the Test Set has the optional current-measuring circuit, Option 003, or that an external power supply is configured to the Test Set. If an external power supply is configured, this test reads current from the external supply.

NOTE: The HP 11807A software does not zero the Test Set current-measuring circuit. Zeroing this circuit should be done periodically according to the instructions found in chapter 4 of the HP 8920A *User's Guide*.

The transmitter and receiver stand-by current drain is measured in Amps.

Pass/Fail Limits Used

Pass/Fail Limit 9. RX Stand-By Current Drain
Pass/Fail Limit 19. TX Current Drain

TEST_02. TX Frequency Error

This test measures the difference between the unmodulated carrier frequency and the assigned carrier frequency. The frequency error is measured in percent.

Pass/Fail Limits Used

Pass/Fail Limit 20. TX Frequency Error

TEST_03. TX Output Power

This test measures the power available at the output terminals of the transmitter when connected to a 50 Ω load.

Testing is performed at the nominal supply voltage and can also be performed with high and low supply voltages for extreme measurements if a programmable power supply is configured to the Test Set. Refer to "**Recommended Equipment**" in **chapter 1 on page 17** for a list of programmable power supplies.

Pass/Fail Limits Used

- Pass/Fail Limit 16. TX Carrier Power
- Pass/Fail Limit 17. TX Carrier Power At High Supply¹
- Pass/Fail Limit 18. TX Carrier Power At Low Supply¹

Test Parameters Used

- Parameter 2. RT High Supply Voltage¹
- Parameter 3. RT Low Supply Voltage¹
- Parameter 4. RT Nominal Supply Voltage
- Parameter 5. RT Test At Extreme Settings

1. These pass/fail limits and test parameters are used only when an external power supply is configured to the Test Set.

TEST_04. TX Audio Frequency Response

This test measures how close the transmitter's audio response follows a flat response line over a given frequency range (determined by test parameters 27-29). The transmitter's audio-frequency response is measured with a constant input level maintained and the error in dB, relative to 1 kHz, is reported.

Audio connections from the radio to the Test Set are required for this test.

Pass/Fail Limits Used

Pass/Fail Limit 14. TX Audio Frequency Resp Roll >2500 Hz

Pass/Fail Limit 15. TX Audio Frequency Response Error

Test Parameters Used

Parameter 26. TX Audio Freq Response Modulation

Parameter 27-29. TX Audio Freq Response Start, Step, and Stop Frequencies

Testing Conditions Fixed by the Software

- A reference is taken at a 1 kHz rate.
- The Test Set AF Analyzer's rms detector is used once the reference is set.

TEST_05. TX Audio Distortion

This test measures the audio-frequency harmonic distortion, which is the change in harmonic content of the input signal as it passes through the transmitter's audio and RF circuits. Transmitter audio distortion is measured in percent. *Audio connections from the radio to the Test Set are required for this test.*

Pass/Fail Limits Used

[Pass/Fail Limit 13. TX Audio Distortion](#)

Test Parameters Used

[Parameter 25. TX Audio Distortion Modulation](#)

Testing Conditions Fixed by the Software

- Audio distortion is measured at a 1 kHz rate.

TEST_06. TX Microphone Sensitivity

This test measures the level of the audio-input signal required to produce standard test modulation.

There are two methods for testing microphone sensitivity, depending upon how you set test parameter 31 (TX mic sens set and meas).

- The first method is the “iterative” test where test parameter 31 is set to “0”. In this case, microphone sensitivity is measured by varying the microphone input voltage until the desired modulation is obtained. The microphone voltage in mVrms for this modulation setting is reported in the test results and compared to pass/fail limit 21 to determine if the test passed or failed.
- The second (and faster) method is the “set and measure” test where test parameter 31 is set to “1”. In this case, microphone voltage is set half-way between the limits set by pass/fail limit 21. The measured %AM modulation is reported in the test results and compared to pass/fail limit 22 to determine if the test passed or failed.

Pass/Fail Limits Used

[Pass/Fail Limit 21. TX Microphone Sensitivity](#)

[Pass/Fail Limit 22. TX Modulation If Set and Meas Mic Sens](#)

Test Parameters Used

[Parameter 31. TX Mic Sens Set and Measure](#)

[Parameter 32. TX Microphone Sensitivity Modulation](#)

TEST_07. TX AM Hum and Noise

This test measures the AM hum and noise level which is the amount of amplitude modulation present on the carrier at the output of the receiver in the absence of any audio-input signal.

Residual AM hum and noise is measured in dB when the transmitter is keyed.

Pass/Fail Limits Used

[Pass/Fail Limit 12. TX AM Hum and Noise](#)

Test Parameters Used

[Parameter 24. TX AM Hum and Noise Modulation](#)

Testing Conditions Fixed by the Software

- Transmitter AM hum and noise is measured at a 1 kHz rate.
- The measurement is made with the Test Set AF Analyzer's peak+ detector.
- If the measured value is ≤ 0 %AM, the test results will calculate hum and noise using 0.001 as a measured value.

TEST_08. RX Hum and Noise

This test measures the receiver's hum and noise ratio (a ratio of the output signal power to the residual output power in the absence of modulation) in decibels. Hum and noise is measured at unsquelched and squelched settings.

Audio connections from the radio to the Test Set are required for this test.

Pass/Fail Limits Used

[Pass/Fail Limit 5. RX Hum and Noise Squelched](#)

[Pass/Fail Limit 6. RX Noise and Hum Unsquelched](#)

Testing Conditions Fixed by the Software

- If the measured value in the squelched position is ≤ 0 %AM, then hum and noise is calculated using 0.0004 as the measured value.

TEST_09. RX Audio Distortion

This test measures audio distortion from the receiver when a standard RF signal (at a level set by test parameter 21) is applied to the radio. Distortion is the voltage ratio, expressed as a percentage, of:

- the rms value of the sum of the second and higher harmonic components,
- to the rms value of the complete signal at the output.

Audio connections from the radio to the Test Set are required for this test.

Pass/Fail Limits Used

[Pass/Fail Limit 3. RX Audio Distortion](#)

Test Parameters Used

[Parameter 14. RX Maximum Audio Power](#)
[Parameter 21. RX Standard RF Input Level](#)
[Parameter 22. RX Standard Test Modulation](#)
[Parameter 23. RX Tolerance For Setting Volume](#)

Testing Conditions Fixed by the Software

- Receiver audio distortion is measured at a 1 kHz rate.

TEST_10. RX Audio Frequency Response

This test measures how close the audio output of a receiver follows a flat response line with constant modulation percentage (fixed by the software) over a given frequency range (set by test parameters 10-12).

Audio Frequency Response is expressed in dB error relative to the reference set by test parameter 9.

Pass/Fail Limits Used

Pass/Fail Limit 4. RX Audio Frequency Response Error

Test Parameters Used

Parameter 9. RX Audio Freq Response Reference Freq
Parameters 10-12. RX Audio Freq Response Start, Step, and Stop Frequencies
Parameter 13. RX Audio Load Impedance
Parameter 14. RX Maximum Audio Power
Parameter 21. RX Standard RF Input Level
Parameter 23. RX Tolerance For Setting Volume

Testing Conditions Fixed by the Software

- The receiver's volume is set to 50% of maximum (to set the constant modulation percentage).

TEST_11. RX Sensitivity S/N

This test measures the RF signal level that is required to produce the standard signal to noise ratio at the output of the receiver. (The standard signal to noise ratio is determined from test parameter 17.) *Audio connections from the radio to the Test Set are required for this test.*

There are two methods for testing receiver sensitivity signal-to-noise, depending upon how you set test parameter 15 (RX Sensitivity S/N Set & Measure):

- The first method is the **iterative** test where test parameter 15 is set to “0”. In this case, the exact sensitivity signal-to-noise ratio is measured with the RF signal generator output level varied until the signal-to-noise level measured at the output of the radio equals the RX Sensitivity S/N Level (set by test parameter 17).
- The second method is the “set and measure” test where test parameter 15 is set to “1”. In this case, the radio is tested with the RF signal generator set to the upper limit of pass/fail limit 7 (RX Sensitivity S/N). Then the signal-to-noise level at the radio output is checked against the RX Sensitivity S/N Level (test parameter 17) to ensure that the signal-to-noise level is greater than or equal to test parameter 17. The exact sensitivity level is not measured.

Pass/Fail Limits Used

[Pass/Fail Limit 7. RX Sensitivity S/N](#)

Test Parameters Used

[Parameter 1. RT External Pad and Cable Loss](#)
[Parameter 14. RX Maximum Audio Power](#)
[Parameter 15. RX Sens S/N Set and Meas](#)
[Parameter 17. RX Sensitivity S/N Level](#)
[Parameter 21. RX Standard RF Input Level](#)
[Parameter 22. RX Standard Test Modulation](#)
[Parameter 23. RX Tolerance For Setting Volume](#)

TEST_12. RX Sensitivity SINAD

This test measures the RF signal level that is required to produce the standard SINAD ratio at the output of the receiver. (The standard SINAD is determined from the RX Sensitivity SINAD level set by test parameter 18.) *Audio connections from the radio to the HP 8920A are required for this test.*

There are two methods for testing receiver sensitivity SINAD, depending upon how you set test parameter 16 (RX Sens SINAD Set & Meas):

- The first method is the “iterative” test where test parameter 16 is set to “0”. In this case, the RF signal generator output level is varied until the SINAD level measured at the radio’s output equals the RX Sensitivity SINAD Level (set by test parameter 18).
- The second method is the “set and measure” test where test parameter 16 is set to “1”. In this case, the radio is tested with the RF signal generator set to the upper limit of pass/fail limit 8 (RX Sensitivity SINAD). Then the SINAD level at the radio’s output is checked against the RX Sensitivity SINAD Level (test parameter 18) to ensure that the SINAD level is greater than or equal to test parameter 18. The exact sensitivity level is not measured.

Pass/Fail Limits Used

Pass/Fail Limit 8. RX Sensitivity SINAD

Test Parameters Used

Parameter 1. RT External Pad and Cable Loss
Parameter 14. RX Maximum Audio Power
Parameter 16. RX Sens SINAD Set and Meas
Parameter 18. RX Sensitivity SINAD Level
Parameter 21. RX Standard RF Input Level
Parameter 23. RX Tolerance For Setting Volume

TEST_13. RX Audio Squelch Sensitivity

This test measures the minimum signal level required from a standard input signal, which, when modulated at standard test modulation, will open the receiver squelch.

Both “threshold” and “tight squelch” sensitivity are measured in this test. Threshold sensitivity is measured with the squelch adjusted for ≥ 20 dB noise quieting. Tight squelch sensitivity is measured with the squelch adjusted to the tight (maximum) test position.

Audio connections from the radio to the Test Set are required for this test.
Threshold and tight squelch sensitivity are both measured in μV .

Pass/Fail Limits Used

[Pass/Fail Limit 10. RX Threshold Squelch Sensitivity](#)
[Pass/Fail Limit 11. RX Tight Squelch Sensitivity](#)

Test Parameters Used

[Parameter 1. RT External Pad and Cable Loss](#)
[Parameter 14. RX Maximum Audio Power](#)
[Parameter 20. RX Sq Sens RF Input When Setting Volume](#)
[Parameter 23. RX Tolerance For Setting Volume](#)

Testing Conditions Fixed by the Software

- Threshold and tight-squelch sensitivity levels are measured starting 5 dB below the limit set by pass/fail limits 10 and 11.
- If a pass/fail limit value is not set up, testing starts at -129 dB for threshold squelch and at -137 dB for tight squelch.

TEST_14. RX Automatic Gain Control

This test measures the radio's ability to deliver a constant level of audio-output power with variable input-signal levels.

Automatic Gain Control is measured in dB.

Pass/Fail Limits Used

Pass/Fail Limit 1. RX AGC Distortion At >50% Audio Levels

Pass/Fail Limit 2. RX AGC Performance

Test Parameters Used

Parameters 6–8. RX AGC Start, Step, and Stop RF Levels

Parameter 14. RX Maximum Audio Power

Parameter 23. RX Tolerance For Setting Volume

Testing Conditions Fixed by the Software

- A reference level is measured with the radio's volume set to 50% of its maximum audio power.
- The radio's distortion is also measured if during the measurement when the RF level is swept, the radio's volume increases by more than 10%.

TEST_15. RX Quick General

This test contains a subset of the complete test list for receivers. It is designed to do a quick evaluation of the receiver using the following tests:

- **TEST_10. RX Audio Frequency Response**
- **TEST_13. RX Audio Squelch Sensitivity**
- **TEST_14. RX Automatic Gain Control**
- **TEST_11. RX Sensitivity S/N**
- **TEST_12. RX Sensitivity SINAD**
- **TEST_09. RX Audio Distortion**
- **TEST_08. RX Hum and Noise**

Pass/Fail Limits Used

Refer to each test shown above for the pass/fail limits that are used.

Test Parameters Used

Besides the test parameters shown below, refer to each test shown above for the test parameters that are used.

- Parameter 14. RX Maximum Audio Power**
- Parameter 21. RX Standard RF Input Level**
- Parameter 23. RX Tolerance For Setting Volume**

TEST_16. TX Quick General

This test contains a subset of the complete test list for transmitters. It is designed to enable you to do a quick evaluation of the transmitter using the following tests:

- **TEST_02. TX Frequency Error**
- **TEST_03. TX Output Power**
- **TEST_05. TX Audio Distortion**
- **TEST_06. TX Microphone Sensitivity**
- **TEST_04. TX Audio Frequency Response**
- **TEST_07. TX AM Hum and Noise**

Pass/Fail Limits Used

Refer to each test shown above for the pass/fail limits that are used.

Test Parameters Used

Refer to each test shown above for the test parameters that are used.

Test Parameter Descriptions

Test parameters are used to define the conditions under which a test will run. You may edit the test parameters to change the default values to meet your specific testing needs and conditions. Test parameters may be used in one or more tests.

For information on editing test parameters, see ["Customizing Testing" in chapter 2 on page 30.](#)

Test parameters remain in battery-backed-up memory until you select a procedure to run. If you wish to prevent them from being lost when a new procedure is selected, you will have to save them in a procedure. See ["Saving a Test Procedure" in chapter 2 on page 47.](#)

To print the list of test parameters, see ["To print TESTS screens:" in chapter 5 on page 192.](#)

There are several different types of test parameters:

- Receiver/Transmitter Test Parameters (RT)
- Receiver Test Parameters (RX)
- Transmitter Test Parameters (TX)
- Extra Test Parameters (XX)

NOTE: Refer to [chapter 2, "Using the Software/HP 8920B, or HP 8920A FW Above Rev. A.14.00," on page 21](#) for details about selecting test parameters for your FM radio.

Parameter 1. RT External Pad and Cable Loss

This parameter allows you to set the amount of loss for any external cables or pads (attenuators) that are connected to the Test Set.

Besides being used in the tests shown below, pad and cable loss is compensated for in power measurements and in signal generator level settings by subroutines in the software whenever:

- converting a Watt reading to dBm, or converting from dBm back to Watts.
- finding the radio's squelch sensitivity.
- setting the Test Set RF level to the desired level in dBm.

For Example:

If a 30 dB attenuator is connected in line with the radio's antenna, you would enter 30 in the value column. Enter the value in dB.

It's Used In the Following Tests:

- [TEST_11. RX Sensitivity S/N](#)
- [TEST_12. RX Sensitivity SINAD](#)
- [TEST_13. RX Audio Squelch Sensitivity](#)
- [TEST_15. RX Quick General](#)

ALL TRANSMITTER TESTS, whenever compensating for external pad and cable loss is necessary.

Parameter 2. RT High Supply Voltage

This test parameter sets the high-power setting on the radio's external power supply (if one is used) when testing under extreme voltage conditions.

For Example:

If your industry standard specifies the high-supply voltage required for extreme measurements as +20% of the normal (nominal) supply voltage, which is +13.2V for the radio's power supply, you would enter **15.8** in the value column. Enter the value in Vdc.

It's Used In the Following Tests:

TEST_03. TX Output Power
TEST_16. TX Quick General

NOTE:

The power supply must be set up in the TESTS menu under the **External Devices** (or **Edit Cnfg**) screen. Refer to the *HP 8920 User's Guide* for information about configuring a power supply.

Parameter 3. RT Low Supply Voltage

This test parameter sets the low-power setting on the radio's external power supply (if one is used) when testing under extreme voltage conditions.

For Example:

If your industry standard specifies the low-supply voltage required for extreme measurements as -20% of the normal (nominal) supply voltage, which is +13.2V for the radio's power supply, you would enter **10.6** in the value column. Enter the value in Vdc.

It's Used In the Following Tests:

TEST_03. TX Output Power

TEST_16. TX Quick General

NOTE:

The power supply must be set up in the TESTS menu under the **External Devices** (or Edit Cnfg) screen. Refer to *HP 8920 User's Guide* for information about configuring a power supply.

Parameter 4. RT Nominal Supply Voltage

This test parameter sets the nominal (that is, normal) power-supply voltage required by the radio. Besides being used in the tests shown below, this test parameter is used whenever the Test Set is initialized prior to starting a Test Procedure.

For Example:

If your radio specification lists the nominal supply voltage to be +13.8V, you would enter **13.8** in the value column. Enter the value in Vdc.

It's Used In the Following Tests:

TEST_03. TX Output Power
TEST_16. TX Quick General

NOTE: The power supply must be set up in the TESTS menu under the **External Devices** (or Edit Cnfg) screen. Refer to *HP 8920 User's Guide* for information about configuring a power supply.

Parameter 5. RT Test At Extreme Settings

This test parameter allows measurements to be made at extreme high and low-power voltage settings (determined by test parameters 2 and 3). This test parameter works only when HP-IB control of the power supply is used.

For Example:

When this test parameter is set to **1** (yes), the tests shown below will run at both high and low-power voltage settings. When this test parameter is set to **0** (no), the tests shown below will run at the nominal-supply voltage setting only.

It's Used In the Following Tests:

TEST_03. TX Output Power

TEST_16. TX Quick General

NOTE:

The power supply must be set up in the TESTS menu under the **External Devices** (or Edit Cnfg) screen. Refer to *HP 8920 User's Guide* for information about configuring a power supply.

Parameters 6–8. RX AGC Start, Step, and Stop RF Levels

These test parameters set the RF level over which the receiver is swept as AGC level is tested.

For Example:

If you want to test AGC level starting at 50 mV and ending at 1 μ V in –10 dB steps:

- You would enter **50000** as the start value for test parameter 6.
- You would enter **–10** as the step value for test parameter 7.
- You would enter **1** as the stop value for test parameter 8.

Enter the values for test parameters 6 and 8 in μ V, and the value for test parameter 7 in dB.

It's Used In the Following Tests:

- [TEST_14. RX Automatic Gain Control](#)
- [TEST_15. RX Quick General](#)

Parameter 9. RX Audio Freq Response Reference Freq

This test parameter sets the audio-frequency reference which is used when testing the receiver's audio-frequency response.

For Example:

If your radio standard recommends using an audio-frequency reference of 1000 Hz for a receiver that is normally used with a loudspeaker, you would enter 1 in the value column. Enter the value in kHz.

It's Used In the Following Tests:

[TEST_10. RX Audio Frequency Response](#)
[TEST_15. RX Quick General](#)

Parameters 10-12. RX Audio Freq Response Start, Step, and Stop Frequencies

Audio Frequency Response Start Frequency is the lowest input signal frequency used for testing the receiver's audio-frequency response.

Audio Frequency Response Step Frequency is the step-size used to vary the input signal frequency for testing the receiver's audio-frequency response.

Audio Frequency Response Stop Frequency is the highest input signal frequency used in for testing the receiver's audio-frequency response.

These test parameters are used to set the start, stop and step frequency settings as the receiver's audio-frequency response is measured for the degree of closeness to which the audio output of a receiver follows a flat response line with constant modulation percentage over the given frequency range.

For Example:

If you want the modulation frequency to be varied from 300 Hz to 3000 Hz in 300 Hz steps:

- You would enter **.3** as the start-frequency value for test parameter 10.
- You would enter **.3** as the step-frequency value for test parameter 11.
- You would enter **3** as the stop-frequency value for test parameter 12.

Enter the value in kHz.

It's Used In the Following Tests:

TEST_10. RX Audio Frequency Response

TEST_15. RX Quick General

Parameter 13. RX Audio Load Impedance

This test parameter allows you to enter the output impedance of the receiver circuitry. Also, the value you set for this test parameter is used by the software to determine how radio volume and squelch will be adjusted during testing.

A load resistor of the same value set with this test parameter must be integrated into the radio or its interface to the Test Set AUDIO IN connector for accurate power settings and test measurements.

For Example:

If your radio specification sets audio-output power into an 2 ohm load, you would enter **2** in the value column. Enter the value in ohms.

It's Used In the Following Tests:

TEST_10. RX Audio Frequency Response

TEST_15. RX Quick General

Parameter 14. RX Maximum Audio Power

This test parameter is used to set the rated audio-output power for the receiver in order for the software to determine the full-scale volume level of the meter screen displayed on the Test Set during testing. Also, this test parameter is used by the software whenever:

- the radio's squelch control is adjusted.
- the radio's volume and/or squelch control is adjusted to its maximum or minimum values.
- the radio's squelch sensitivity is to be found.

For Example:

If the audio-output power for your receiver is rated at 5 Watts, you would enter 5 in the value column. Enter the value in Watts. The meter screen shown during testing will show a full-scale volume level of 15 Watts since the level is scaled up by 50%.

It's Used In the Following Tests:

TEST_08. RX Hum and Noise
TEST_09. RX Audio Distortion
TEST_10. RX Audio Frequency Response
TEST_11. RX Sensitivity S/N
TEST_12. RX Sensitivity SINAD
TEST_13. RX Audio Squelch Sensitivity
TEST_14. RX Automatic Gain Control
TEST_15. RX Quick General

Parameter 15. RX Sens S/N Set and Meas

This test parameter allows you to choose how the test for sensitivity signal-to-noise (S/N) will be performed.

For Example:

Setting this test parameter to “0” causes the software to perform a pass/fail measurement of the receiver’s sensitivity S/N. In this case, the Test Set RF generator’s output level is set to the upper limit of pass/fail limit 7 for “RX sensitivity S/N” and the measured S/N level at the radio’s output is checked against test parameter 17 for “RX sensitivity S/N level”. If the S/N level is within the specified limits the test passes and the measured S/N sensitivity is displayed in the “**Measured value**” column.

Setting this test parameter to “1” causes the software to perform a faster, iterative measurement of sensitivity S/N. In this case, sensitivity S/N is measured by setting the RF level to the upper limit of pass/fail limit 7 “RX sensitivity S/N”. The Test Set RF generator’s output level is varied until the S/N level measured at the radio’s output. The S/N level measured in dB is displayed in the “**Measured value**” column as the sensitivity S/N level.

It’s Used In the Following Tests:

[TEST_11. RX Sensitivity S/N](#)
[TEST_15. RX Quick General](#)

Parameter 16. RX Sens SINAD Set and Meas

This test parameter allows you to choose how the test for receiver sensitivity SINAD will be performed.

For Example:

Setting this test parameter to “0” causes the software to vary the RF level until the desired SINAD is obtained. In this case, the measurement starts at the upper limit of pass/fail limit 8 “RX sensitivity SINAD” or at 0.5 μV if no limit for pass/fail limit 8 is given. The measured sensitivity SINAD value is displayed in the “**Measured value**” column.

Setting this test parameter to “1” causes the software to perform a faster, iterative measurement of sensitivity SINAD. In this case, the Test Set RF generator’s output level is set to the “RX standard RF input level” (determined by the value in test parameter 21). The RF generator’s output level is varied until the SINAD sensitivity level set by pass/fail limit 8 (“RX sensitivity SINAD”) is measured at the radio’s output. The SINAD sensitivity level measured in dB is then displayed in the “**Measured value**” column.

It’s Used In the Following Tests:

- TEST_12. RX Sensitivity SINAD
- TEST_15. RX Quick General

Parameter 17. RX Sensitivity S/N Level

This test parameter sets the target value of the signal-to-noise ratio that is to be measured at the receiver's audio-output terminals. During testing the standard RF input level (test parameter 21) is adjusted until the ratio of output signal with modulation, to the output signal without modulation is at the RX sensitivity S/N level (test parameter 17).

However, if you use the Set and Measure technique (test parameter 15 set to '1'), there is no target value. In this case, the test system's RF signal generator is set to the upper limit of the sensitivity value in pass/fail limit 7 and the signal-to-noise measured. The measured value must then be greater than the RX sensitivity S/N level (test parameter 17) in order for the test to pass.

For Example:

If your industry standard states that a 10 dB signal plus noise-to-noise ratio is required, you would enter 10 in the value column. Enter the value in dB.

It's Used In the Following Tests:

[TEST_11. RX Sensitivity S/N](#)

[TEST_15. RX Quick General](#)

Parameter 18. RX Sensitivity SINAD Level

This test parameter sets the target value of the SINAD ratio that is to be measured at the receiver's audio-output terminals.

However, if you use the Set and Measure technique (test parameter 16 set to 1), there is no target value. In this case, the test system's RF signal generator is set to the upper limit of the sensitivity value in pass/fail limit 8 and the SINAD is measured. The measured value must then be greater than the RX sensitivity SINAD level (test parameter 18) for the test to pass.

For Example:

If your industry standard specifies the standard SINAD ratio to be 10 dB, you would enter 10 in the value column. Enter the value in dB.

It's Used In the Following Tests:

[TEST_12. RX Sensitivity SINAD](#)

[TEST_15. RX Quick General](#)

Parameter 19. RX Set Radio Volume

This test parameter allows you to have the software prompt the test operator to adjust volume on the radio during testing or to allow the software to take the volume setting where it is.

You can decrease testing time by setting this test parameter to **0=no** if you are willing to let all tests run at the same volume (audio) level. The industry standard often requires adjusting volume to specific volume levels.

For example:

If you want the test operator to be able to adjust radio volume during testing, you would enter **1** in the value column. If you want the Test Set to take the volume setting as it is, you would enter **0** in the value column.

It's Used In the Following Tests:

ALL TESTS, whenever the radio's volume is adjusted during testing.

Parameter 20. RX Sq Sens RF Input When Setting Volume

This test parameter sets the input RF signal source that is used when the volume control is adjusted during audio-squelch sensitivity testing.

For Example:

If your industry standard requires the input signal source to be adjusted to 1 μV when the volume control is adjusted to obtain, for example, 50% of rated output, you would enter 1 in the value column. Enter the value in μV .

It's Used In the Following Tests:

[TEST_13. RX Audio Squelch Sensitivity](#)

[TEST_15. RX Quick General](#)

Parameter 21. RX Standard RF Input Level

This test parameter sets the standard RF input level (which is the HP 8920A RF generator's output level) that is used in receiver testing.

For Example:

If your industry standard sets the standard input-signal level to be 1000 μV , you would enter 1000 in the value column. Enter the value in μV .

It Is Used In the Following Tests:

- TEST_08. RX Hum and Noise
- TEST_09. RX Audio Distortion
- TEST_10. RX Audio Frequency Response
- TEST_11. RX Sensitivity S/N
- TEST_12. RX Sensitivity SINAD
- TEST_15. RX Quick General

Parameter 22. RX Standard Test Modulation

This test parameter sets the test modulation percentage used by the receiver in the tests shown below. Also, this test parameter is used by the software when the Test Set is set to the standard receiver mode (RX).

For Example:

If your industry standard sets the standard test modulation at 30%, you would enter 30 in the value column. Enter the value in percent.

It's Used In the Following Tests:

- TEST_08. RX Hum and Noise
- TEST_11. RX Sensitivity S/N
- TEST_15. RX Quick General

Parameter 23. RX Tolerance For Setting Volume

This test parameter sets a tolerance window for the maximum percentage of error allowed on the meter screen. The meter screen is displayed on the Test Set during testing for manually setting the radio's volume. The tolerance for setting volume should be as accurate as the radio's volume control will allow.

For Example:

For example, if maximum audio power is 10 watts (set up in test parameter 14, "RX Maximum Audio Power") the meter screen on the HP 8920A will display a full-scale reading of 15 Watts since the software scales the meter screen by 50%. The tolerance window displayed on the meter screen will be a percentage of the 10 Watts. In this example, test parameter 23 set to "10%" would create a tolerance window of 1 Watt, "5%" would create a tolerance window of 0.5 Watts, and so forth.

The value should be determined based on the highest accuracy the radio volume control allows. Enter a number equal to the accuracy you want and then run a test to see if the radio volume control allows you to make the setting. If you can not adjust the volume within the tolerance window, enter a larger number. Enter the value in % error.

It's Used In the Following Tests:

- [TEST_08. RX Hum and Noise](#)
- [TEST_09. RX Audio Distortion](#)
- [TEST_10. RX Audio Frequency Response](#)
- [TEST_11. RX Sensitivity S/N](#)
- [TEST_12. RX Sensitivity SINAD](#)
- [TEST_13. RX Audio Squelch Sensitivity](#)
- [TEST_14. RX Automatic Gain Control](#)
- [TEST_15. RX Quick General](#)

Parameter 24. TX AM Hum and Noise Modulation

This test parameter sets percentage of modulation for the transmitter when AM hum and noise is measured.

For Example:

If your industry standard sets the AM hum and noise level for transmitters at 35 dB below 50% modulation at 1 kHz, you would enter 50 in the value column. Enter the value in percent.

It's Used In the Following Tests:

[TEST_07. TX AM Hum and Noise](#)

[TEST_16. TX Quick General](#)

Parameter 25. TX Audio Distortion Modulation

This test parameter sets the modulation percentage used when testing the transmitter's audio distortion.

For Example:

If your industry standard requires a sine wave of less than 1% distortion at 1 kHz to be applied to the transmitter input at a level to produce 80% modulation, you would enter **80** in the value column. Enter the value in percent.

It's Used In the Following Tests:

TEST_05. TX Audio Distortion

TEST_16. TX Quick General

Parameter 26. TX Audio Freq Response Modulation

This test parameter sets the modulation percentage used when testing the transmitter's audio-frequency response.

For Example:

If your industry standard requires the modulating frequency to be varied between 300 and 3000 Hz and the audio-input level applied should maintain a constant 50% modulation, you would enter 50 in the value column. Enter the value in percent AM.

It's Used In the Following Tests:

[TEST_04. TX Audio Frequency Response](#)
[TEST_16. TX Quick General](#)

Parameter 27-29. TX Audio Freq Response Start, Step, and Stop Frequencies

The start frequency test parameter sets the lowest modulation frequency used for testing the transmitter's audio-frequency response.

The step frequency test parameter sets the step size used to vary the modulation frequency for testing the transmitter's audio-frequency response.

The stop frequency test parameter sets the highest modulation frequency used for testing the transmitter's audio-frequency response.

For Example:

If your industry standard determines that the modulation frequency used for testing the transmitter's audio-frequency response should start at 300 Hz and stop at 3 kHz in 500 Hz steps, you would enter:

- 0.3 in the value column for test parameter 27.
- 0.5 in the value column for test parameter 28.
- 3 in the value column for test parameter 29.

Enter the value in kHz.

It's Used In the Following Tests:

- [TEST_04. TX Audio Frequency Response](#)
- [TEST_16. TX Quick General](#)

Parameter 30. TX Dekey Between TX Tests

This test parameter prompts the test operator to de-key the radio between each transmitter (TX) test or allows the radio to transmit continuously.

For Example:

If you want the Test Procedure sequence to proceed as quickly as possible and are not concerned that the radio transmits continuously between tests or if your radio has a transmitter with an automatic timeout feature which de-keys the radio, you would enter **0** in the value column, otherwise, enter **1** in the value column.

It's Used In the Following Tests:

ALL TRANSMITTER TESTS, whenever the test operator is required to de-key the transmitter, that is, when test parameter 30 is set to **1**.

Parameter 31. TX Mic Sens Set and Measure

This test parameter allows you to choose how the test for microphone sensitivity will be performed.

For Example:

Setting this test parameter to “0” causes the software to perform a pass/fail measurement of the microphone’s sensitivity. In this case, modulation is set to the “TX microphone sensitivity modulation” value (set by test parameter 32) and the measured microphone sensitivity in mVrms is displayed in the “**Measured value**” column.

Setting this test parameter to “1” causes the software to perform a faster, iterative measurement of microphone sensitivity. In this case, the Test Set AF generator’s output level is set to the half-way value of pass/fail limit 21 “TX microphone sensitivity” and the %AM modulation measured at the microphone input is displayed in the “**Measured value**” column.

It’s Used In the Following Tests:

TEST_06. TX Microphone Sensitivity
TEST_16. TX Quick General

Parameter 32. TX Microphone Sensitivity Modulation

This test parameter sets the modulation percentage that is used when testing the transmitter's microphone sensitivity when "TX mic sens set and measure" (test parameter 31) is set to 0.

For Example:

If test parameter 31 is set to 0 and you want to test the microphone sensitivity in mVrms with 80% modulation, you would enter 80 in the value column. Enter the value in percent AM.

It's Used In the Following Tests:

[TEST_06. TX Microphone Sensitivity](#)
[TEST_16. TX Quick General](#)

Parameter 33. TX User/System Key UUT

This test parameter allows you to determine if the test operator (user) should key the transmitter or if the Test Set (system) should key the transmitter during testing. Having the Test Set key the transmitter requires connections from the radio to the Test Set MIC/ACC connector.

For Example:

If you want the Test Set to automatically key the transmitter, you would enter **1** in the value column, otherwise, enter **0** in the value column.

It's Used In the Following Tests:

ALL TRANSMITTER TESTS, if this test parameter is turned on (that is, set to **1**).

Parameter 34. XX Secure Frequency Information

This test parameter allows you to secure the radio's channels

This test parameter provides security for the radio by preventing the channel's frequency from being seen on the Test Set display and from being printed in the test results. Instead, the receive frequency is shown as "**RX=FXXX MHz**" and the transmit frequency is shown as "**TX=FXXX MHz**" where "**FXXX**" is the secured frequency.

For Example:

If you want to prevent the radio channel's receive and transmit frequencies from being printed with the test results, you would enter **1** in the value column, otherwise, enter **0** in the value column.

It's Used in the Following Tests:

ALL TESTS, if this test parameter is turned on (that is, set to **1**).

Pass/Fail Limit Descriptions

Pass/Fail Limits define the values a measurement's result is compared against to determine if the UUT meets its specified standards.

For information on editing Pass/Fail Limits, see "[Customizing Testing](#)" in [chapter 2 on page 30](#).

The list of pass/fail limits is arranged alphabetically. The first few capital letters in the title of each pass/fail limit indicate what the pass/fail limit refers to (see Prefixes and Abbreviations at the beginning of this chapter).

Pass/Fail Limits remain in battery-backed-up memory until you select a procedure to run. If you wish to prevent them from being lost when a new procedure is selected you will have to save them in a procedure. See "[Saving a Test Procedure](#)" in [chapter 2 on page 47](#). To print the list of Pass/Fail Limits, see "[To print TESTS screens:](#)" in [chapter 5 on page 192](#).

There are two types of pass/fail limits:

- Receiver Test Pass/Fail Limits (RX)
- Transmitter Test Pass/Fail Limits (TX)

NOTE: Refer to [chapter 2, "Using the Software/HP 8920B, or HP 8920A FW Above Rev. A.14.00," on page 21](#) for details about selecting pass/fail limits for your FM radio.

Pass/Fail Limit 1. RX AGC Distortion At >50% Audio Levels

This sets the pass/fail limits that are used in the automatic gain-control test when distortion is measured at audio levels greater than 50%.

Pass/fail limits are determined from an applicable radio specification or industry standard, such as:

- Radio specification: AGC Distortion
- Industry standard: EIA RS-382-A, Section 5, *Automatic Gain Control*

For Example:

If your industry standard states that AGC distortion shall not be permitted to exceed 10% and you want to test the radio's upper limits, you would enter 0 in the lower-limit column and 10 in the upper-limit column.

Limits are entered in percent.

It's Used In The Following Tests:

- [TEST_14. RX Automatic Gain Control](#)
- [TEST_15. RX Quick General](#)

Pass/Fail Limit 2. RX AGC Performance

This sets the pass/fail limits for the AGC circuits as the audio-output power is measured with variable AGC RF input-signal levels.

Pass/fail limits are determined from an applicable industry standard, such as:

- Industry standard: EIA RS-382-A, Section 5, *Automatic Gain Control*

For Example:

If your industry standard states that the audio-output power should not exceed 30 dB relative to the ratio of maximum power output over the signal range to the output at the usable sensitivity point, and you want to test the radio's upper limits, you would enter **0** in the lower-limit column and **30** in the upper-limit column. Limits are entered in dB.

It's Used In The Following Tests:

[TEST_14. RX Automatic Gain Control](#)

[TEST_15. RX Quick General](#)

Pass/Fail Limit 3. RX Audio Distortion

This sets the pass/fail limits for measuring the receiver's audio distortion while receiving a standard signal source.

Pass/fail limits are determined from an applicable radio specification or industry standard, such as:

- Radio specification: Audio Distortion
- Industry standard: EIA RS-382-A, Section 9, *Receiver Audio Power Output*

For Example

If your industry standard states that audio distortion should not exceed 10% at a normal audio output and you want to test the radio's upper limits, you would enter 0 in the lower-limit column and 10 in the upper-limit column. Limits are entered in percent.

[TEST_09. RX Audio Distortion](#)

[TEST_15. RX Quick General](#)

Pass/Fail Limit 4. RX Audio Frequency Response Error

This sets the pass/fail limits for testing the receiver's audio-frequency response.

Pass/fail limits are determined from an applicable radio specification or industry standard, such as:

- Radio specification: Audio Frequency Response
- Industry standard: EIA RS-382-A, Section 10, *Audio Frequency Response*

For Example:

If your industry standard sets the limits for audio response to not vary more than +2 dB to -14 dB and you want to test both limits on the radio, you would enter -14 in the lower-limit column and 2 in the upper-limit column. Limits are entered in dB.

It's Used In The Following Tests:

- [TEST_10. RX Audio Frequency Response](#)
- [TEST_15. RX Quick General](#)

Pass/Fail Limit 5. RX Hum and Noise Squelched

This sets the pass/fail limits for receiver hum and noise testing, with squelch set to maximum.

Pass/fail limits are determined from an applicable radio specification or industry standard, such as:

- Radio specification: Hum and Noise
- Industry standard: EIA RS-382-A, Section 11, *Hum and Noise Ratio*

For Example:

If your industry standard sets the squelched hum and noise level measured at the audio-output terminals of the receiver to not be more than -45 dB and you want to test the radio's lower limits, you would enter **45** in the lower-limit column and **0** in the upper-limit column. Limits are entered in dB.

It's Used In The Following Tests:

[TEST_08. RX Hum and Noise](#)

[TEST_15. RX Quick General](#)

Pass/Fail Limit 6. RX Noise and Hum Unsquelled

This sets the pass/fail limits for receiver hum and noise testing with squelch set to minimum.

Pass/fail limits are determined from an applicable radio specification or industry standard, such as:

- Radio specification: Hum and Noise
- Industry standard: EIA RS-382-A, Section 11, *Hum and Noise Ratio*

For Example:

If your industry standard states that the unquelled hum and noise level measured at the audio-output terminals of the receiver should not be more than –35 dB and you want to test the radio's lower limits, you would enter –35 in the lower-limit column and 0 in the upper-limit column. Limits are entered in dB.

It's Used In The Following Tests:

[TEST_08. RX Hum and Noise](#)

[TEST_15. RX Quick General](#)

Pass/Fail Limit 7. RX Sensitivity S/N

This sets the pass/fail limits that are used for measuring receiver's sensitivity in terms of its signal-to-noise ratio.

Pass/fail limits are determined from an applicable radio specification or industry standard, such as:

- Radio specification: Sensitivity
- Industry standard: EIA RS-382-A, Section 4, *Sensitivity*

For Example:

If your industry standard sets the radio's sensitivity for testing signal-to-noise 1 μV and you want to test the radio's upper limits, you would enter **0** in the lower-limit column and **1** in the upper-limit column. Limits are entered in μV .

It's Used In The Following Tests:

- [TEST_11. RX Sensitivity S/N](#)
- [TEST_15. RX Quick General](#)

Pass/Fail Limit 8. RX Sensitivity SINAD

This sets the pass/fail limits that are used for measuring receiver's sensitivity in terms of its signal-to-noise and distortion ratio (SINAD).

Pass/fail limits are determined from an applicable radio specification, such as:

- Radio specification: Sensitivity

For Example:

If your radio specification sets the radio's sensitivity for testing SINAD at 1.5 μV and you want to test the radio's upper limits, you would enter 0 in the lower-limit column and 1.5 in the upper-limit column. Limits are entered in μV .

It's Used In The following Tests:

[TEST_12. RX Sensitivity SINAD](#)

[TEST_15. RX Quick General](#)

Pass/Fail Limit 9. RX Stand-By Current Drain

This sets the pass/fail limits for testing receiver stand-by current drain (with squelch set to maximum).

Pass/fail limits are determined from an applicable radio specification, such as:

- Radio specification: Maximum Battery Drain

For Example:

If your radio specification sets the maximum battery drain, while the radio is receiving, as 5 amperes and you want to test the radio's upper limits, you would enter 0 in the lower-limit column and 5 in the upper-limit column. Limits are entered in amps.

It's Used In The Following Test:

TEST_01. TX and RX Stand-by Current Drain

Pass/Fail Limit 10. RX Threshold Squelch Sensitivity

This sets the pass/fail limits for testing audio-squelch sensitivity, with squelch and volume adjusted for the threshold settings.

Pass/fail limits are determined from an applicable radio specification or industry standard, such as:

- Radio specification: Audio Squelch Sensitivity
- Industry standard: EIA RS-382-A, Section 6, *Audio Squelch Sensitivity*

For Example:

If your radio specification sets audio-squelch sensitivity to be 1 μV and you want to test the radio's upper limit, you would enter 0 in the lower-limit column and 1 in the lower-limit column. Limits are entered in μV .

It's Used In The Following Tests:

- [TEST_13. RX Audio Squelch Sensitivity](#)
- [TEST_15. RX Quick General](#)

Pass/Fail Limit 11. RX Tight Squelch Sensitivity

This sets the pass/fail limits for testing the receiver's tight-squelch sensitivity in the audio-squelch sensitivity test.

Pass/fail limits are determined from an applicable radio specification or industry standard, such as:

- Radio specification: Audio Squelch Sensitivity
- Industry standard: EIA RS-382-A, Section 6, *Audio Squelch Sensitivity*

For Example:

If your industry standard states that the input signal required to produce the tight audio-squelch sensitivity should be no greater than 1000 μV and no less than 30 μV and you want to test both limits on the radio, you would enter **30** in the lower-limit column and **1000** in the upper-limit column. Limits are entered in μV .

It's Used In The Following Tests:

- [TEST_13. RX Audio Squelch Sensitivity](#)
- [TEST_15. RX Quick General](#)

Pass/Fail Limit 12. TX AM Hum and Noise

This sets the pass/fail limits for testing transmitter AM hum and noise.

Pass/fail limits are determined from an applicable radio specification or industry standard, such as:

- Radio specification: AM Noise
- Industry standard: EIA RS-382-A, Section 18, *Hum and Noise Level*

For Example:

If your industry standard states that the AM hum and noise level for the transmitter should be 35 dB below 50% modulation at 1000 Hz and you want to test the radio's upper limits, you would enter 0 in the lower-limit column and -35 in the upper-limit column. Limits are entered in dB.

It's Used In The Following Tests:

- [TEST_07. TX AM Hum and Noise](#)
- [TEST_16. TX Quick General](#)

Pass/Fail Limit 13. TX Audio Distortion

This sets the pass/fail limits for testing transmitter audio distortion.

Pass/fail limits are determined from an applicable radio specification or industry standard, such as:

- Radio specification: Audio Distortion
- Industry standard: EIA RS-382-A, Section 16, *Audio Frequency Harmonic Distortion*

For Example:

If your industry standard states that the harmonic distortion factor should not exceed 10% and you want to test the radio's upper limits, you would enter **0** in the lower-limit column and **10** in the upper-limit column. Limits are entered in %.

It's Used In The Following Tests:

- [TEST_05. TX Audio Distortion](#)
- [TEST_16. TX Quick General](#)

Pass/Fail Limit 14. TX Audio Frequency Resp Roll >2500 Hz

This sets the pass/fail limits that are used when the audio-frequency response of the transmitter is measured at frequencies greater than 2.5 kHz. At frequencies greater than 2.5 kHz, a roll-off from the flat response line of the transmitter is permitted over a given continuous frequency range (determined by test parameters 27-29).

Pass/fail limits are determined from an applicable radio specification or industry standard, such as:

- Radio specification: Audio Frequency Response
- Industry standard: EIA RS-382-A, Section 17, *Audio Frequency Response (Transmitter)*

For Example:

If your industry standard indicates that the audio-frequency response can have a 6 dB per octave roll-off from the flat response line at frequencies greater than 2.5 kHz and you want to test both limits on the radio, you would enter **0** in the lower-limit column and **6** in the upper-limit column. Limits are entered in dB per octave.

It's Used In The Following Tests:

- TEST_04. TX Audio Frequency Response**
- TEST_16. TX Quick General**

Pass/Fail Limit 15. TX Audio Frequency Response Error

This sets the pass/fail limits for testing the transmitter's audio-frequency response.

Pass/fail limits are determined from an applicable radio specification or industry standard, such as:

- Radio specification: Audio Frequency Response
- Industry standard: EIA RS-382-A, Section 17, *Audio Frequency Response (Transmitter)*

For Example:

If your industry standard indicates that the audio-frequency response should not vary more than +2 to -14 dB and you want to test both limits on the radio, you would enter -14 in the lower-limit column and 2 in the upper-limit column. Limits are entered in dB.

It's Used In The Following Tests:

- [TEST_04. TX Audio Frequency Response](#)
- [TEST_16. TX Quick General](#)

Pass/Fail Limit 16. TX Carrier Power

This sets the pass/fail limits for testing the transmitter's carrier power at its normal-power setting.

Pass/fail limits are determined from an applicable radio specification or industry standard, such as:

- Radio specification: Carrier Output Power
- Industry standard: EIA RS-382-A, Section 13, *Transmitter Carrier Power Output*

For Example:

If your radio specification sets the RF carrier-output power as 2.5 Watts and you want to test both limits on your radio, you could enter **2.5** in the lower-limit column and choose an appropriate upper-limit, for example **4** Watts. Limits are entered in Watts.

It's Used In The Following Tests:

[TEST_03. TX Output Power](#)

[TEST_16. TX Quick General](#)

Pass/Fail Limit 17. TX Carrier Power At High Supply

This sets the pass/fail limits for testing the high-power setting for the radio's external power supply (if one is used).

Pass/fail limits are determined from an applicable radio specification or industry standard, such as:

- Radio specification: Carrier Output Power
- Industry standard: EIA RS-382-A, Section 13, *Transmitter Carrier Power Output*

For example:

If your radio's power supply is rated to output 10 Watts at its high-supply setting, you might enter **9** in the lower-limit column and **11** in the upper-limit column and test both limits. Limits are entered in Watts.

It's Used In The Following Tests:

- [TEST_03. TX Output Power](#)
- [TEST_16. TX Quick General](#)

Pass/Fail Limit 18. TX Carrier Power At Low Supply

This sets the pass/fail limits for testing the low-power setting for the radio's external power supply (if one is used).

Pass/fail limits are determined from an applicable radio specification or industry standard, such as:

- Radio specification: Carrier Output Power
- Industry standard: EIA RS-382-A, Section 13, *Transmitter Carrier Power Output*

For example:

If your radio's power supply is rated to output 7 Watts at its low-supply setting, you might enter **6** in the lower-limit column and **8** in the upper-limit column and test both limits. Limits are entered in Watts.

It's Used In The Following Tests:

TEST_03. TX Output Power

TEST_16. TX Quick General

Pass/Fail Limit 19. TX Current Drain

This sets the pass/fail limits for testing the transmitter's current drain.

Pass/fail limits are determined from an applicable radio specification, such as:

- Radio specification: Maximum Battery Drain, Transmit at Rated Power

For Example:

If your radio specification sets the maximum battery drain while the radio is transmitting to be 10 amperes and you want to test the radio's upper limits, you would enter 0 in the lower-limit column and 10 in the upper-limit column. Limits are entered in Amps.

It's Used In The Following Tests:

[TEST_01. TX and RX Stand-by Current Drain](#)

[TEST_16. TX Quick General](#)

ALL TESTS, whenever a system initialization is done.

Pass/Fail Limit 20. TX Frequency Error

This defines the pass/fail limits when testing the transmitter's frequency error.

Pass/fail limits are determined from an applicable radio specification or industry standard, such as:

- Radio specification: Frequency Stability
- Industry standard: EIA RS-382-A, Section 19 *Transmitter Frequency Stability*

For Example:

If your industry standard states that the radio's minimum frequency stability should be $\pm 0.005\%$ at any time during normal operation, you would enter -0.005 in the lower-limit column and 0.005 in the upper-limit column. Limits are entered in percent.

It's Used In The Following Tests:

[TEST_02. TX Frequency Error](#)

[TEST_16. TX Quick General](#)

ALL TESTS, whenever a system initialization is done.

Pass/Fail Limit 21. TX Microphone Sensitivity

This sets the pass/fail limits for the nominal voltage at the input of the microphone which will cause standard test modulation.

Pass/fail limits are determined from an applicable radio specification, such as:

- Radio specification: Microphone Sensitivity

For Example:

If your standard defines microphone sensitivity as 2.5 mVrms \pm 20% and you want to test both limits on the radio, you would enter 2 in the lower-limit column and 3 in the upper-limit column. Limits are entered in mVrms.

It's Used In The Following Tests:

[TEST_06. TX Microphone Sensitivity](#)

[TEST_16. TX Quick General](#)

ALL TESTS, whenever the transmitter's modulation is set to the desired %AM.

Pass/Fail Limit 22. TX Modulation If Set and Meas Mic Sens

If test parameter 31 “TX Mic Sens Set and Measure” is set to “1”, this pass/fail limit then sets the modulation for testing microphone sensitivity.

pass/fail limits are determined from an applicable radio specification, such as:

- Radio specification: Microphone Sensitivity

For Example:

If your industry standard specifies that the modulation for testing microphone sensitivity should be 80% \pm 5% accuracy and you want to test both limits on the radio, you would enter **75** in the lower-limit column and **85** in the upper-limit column. Limits are entered in percent.

It's Used In The Following Tests:

- [TEST_06. TX Microphone Sensitivity](#)
- [TEST_16. TX Quick General](#)

5

Reference (Alphabetical)

This chapter provides detailed descriptions of the features and functions of the HP 11807A,E software. Topics are arranged alphabetically for quick, easy reference.

Conventions Used

Special presentations of text in this manual reflect the appearance of the item being referred to.

Examples of these special presentations are:

TESTS

A key on the test set.

Procedure:

Characters displayed on the CRT display.

k1 (**Run Test**)

*A USER key, in the key column next to the CRT. **Run Test** is displayed on the CRT.*

0.000000

A field on the CRT where entries can be made.

Titles of documentation are printed in italics.

The term test set refers to the HP 8920A,B,D. In the steps in this manual the following words are used to describe cursor and entry actions:

- **select** refers to pressing the knob after positioning the cursor in front of the appropriate field (**inverse video** area).
- **choose** means to position the cursor in front of an item in the **Choices:** or **To Screen** menu in the lower right corner of the CRT display, and then press the knob.
- **enter** means to use the numeric keypad, and the ENTER key or measurement units keys to make entries to fields. In some procedures, **enter** is used to describe the action of entering characters into a field.

Copying Files

Files can be copied from one mass-storage device to another using IBASIC COPY commands. For example, to copy a file from an inserted memory card to the left drive of an external dual-disk drive with HP-IB address 700, press TESTS. Select **IBASIC Cntrl** from the **SET UP TEST SET** list (or **IBASIC** from the **Test Function** field). Position the cursor to the IBASIC command line and select it. Using the character list that appears in the **Choices** menu, enter the following command:

```
COPY "MY_TEST:INTERNAL" TO "MYFILE: ,700,0"
```

You can copy a file from a memory card to an SRAM memory card by loading the program from the memory card into the test set, inserting an initialized SRAM memory card, and then using the IBASIC SAVE command. Enter the following:

```
SAVE "MY_TEST:INTERNAL"
```

You can list the names of the files stored in a memory card or disk catalog by using the IBASIC CAT command. To display a list of file names on a memory card, enter the following:

```
CAT ":INTERNAL" or CAT
```

The mass storage powers-up to memory card as a default. If you did not change this setting, then **":INTERNAL"** is optional. If you are entering many characters into the IBASIC command line, you may want to connect a terminal to the test set. See "[Serial Connection](#)" on page 185. You will also want to use a terminal if you have many files to list because file names displayed with the **CAT** IBASIC command scroll past the top of the test set's CRT display and cannot be scrolled down.

IBASIC is used when writing your own programs and is not explained in this manual. If you need to write your own IBASIC programs you may acquire the following manuals:

- HP 8920A,D
 - *HP Instrument Basic User's Handbook* HP part number E2083-90000.
 - *HP 8920A Programming Manual* HP part number 08920-90220.
- HP 8920B
 - *HP Instrument Basic User's Handbook Version 2.0* HP part number E2083-90005.
 - *HP 8920B Programming Manual* HP part number 08920-90222.

See also: "[Initializing a Memory Card](#)" on page 177.

Data Collection (Saving and Retrieving Test Results)

The software has the capability to save test results to an SRAM memory card, to a disk drive, or to a PC.

Collection to a Memory Card or Disk

You will have to make entries into the **External Devices** (Edit Config) screen to describe the type of data collection you are using.

To configure External Devices entries:

1. Press TESTS
2. Select **External Devices** from the **SET UP TEST SET** list (or **Edit Cnfg** from the **Test Function** field).
3. Position the cursor to the **Calling Name** field and select it.
4. Using the list of characters in the **Choices** menu, enter **DATA C** into the **Calling Name** next to **Inst# 1**. The entry will look like:

```
1 DATA C
```

Note: For some SW revisions, DATA C will appear in the **Choices** menu. In this case, you may select DATA C, then Done instead of typing each character individually.

5. Position cursor to the **Addr** field and select it.
6. Using the DATA keypad, enter a number into **Addr**, depending on the type of storage media you will be using (press ENTER when complete):

If you are using a memory card, enter **1** into the **Addr**:

```
1 DATA C 1
```

If you are using a disk drive, enter the HP-IB disk address. For example, if the drive you are using is set to 700, then the display needs to look like:

```
1 DATA C 700
```

Calling names can be entered in any order.

The test software supports data storage on Logical Interchange Format (LIF) and Disk Operating System (DOS) disk formats. Storage can be to any of the following file types:

- ASCII files under LIF
- BDAT files under LIF
- HP-UX files under LIF
- DOS files under DOS

You will be specifying the file type with the entry you make into the **Options** field immediately below **DATA C**. If no file type is entered, and the disk format is LIF, the software will select an HP-UX file type. If no file type is entered, and the disk format is DOS, the software will select a DOS file type. For example, if you are using a DOS file and you are not using an extension on the file name, the entry on this screen will look like:

```
1  DATA C    700
```

If you are using an ASCII, BDAT or HP-UX file, you can specify the number of records allocated to the file. The DOS file is automatically updated as data is stored, so record allocation is not required. If you are using HP-UX files, you will have to enter **REC=** to establish a usable number of records. **REC=20480** sets the size to be the same as the default number of 256 byte records used for ASCII files (80×256). You can enter the **REC=** after the file type. For example, to use an ASCII file with 200 records of 256 bytes each, you will enter **ASCII REC=200** into the **Options** field.

NOTE: For some software revisions, **REC=** and **ASCII REC=** will appear in the **Choices** menu. In this case, you may select **REC=** or **ASCII REC=**, enter the number of records using the **DATA** keypad, then select **Done**, instead of typing in each character individually.

The display will appear as follows:

```
1  DATA C    700
   ASCII REC=200
```

The default number of records, used when no **REC=** entry is made, is 80.

Items in the **Options** field can be separated by a comma or a space.

See "**Initializing a Disk**" on page 169 if using a new disk. See "**Initializing a Memory Card**" on page 177 if using a new memory card. The file types under LIF can be used by the test set's IBASIC controller and some HP workstations. The DOS format is required if you wish to use the disk with a PC.

Table 7 Data Collection (Saving/Retrieving Tests) Configuration Summary

Inst#	Calling Name Options	Model	Addr	Description
1	DATA Collection	don't care	7xx ¹	To HP-IB disk drive
1	DATA Collection	don't care	1	To memory card
Options: ²	File types of ASCII, or BDAT, or (EXT), ³ or blank, ⁴ REC=xxxxx, (number of records)	don't care	7xx ¹	LIF format LIF format DOS file type DOS or HP-UX file type ⁴ Number of records
1	DATA Collection	don't care	9	Serial to external computer (laptop)

1. xx=Last two digits of HP-IB address.
2. These options apply to disk drive and memory card data collection. They do not apply when collecting data with Addr=9.
3. A DOS file name extension. For example, the file name may be CELL1.EXT.
4. DOS is used if the disk format is DOS. HP-UX is used if the disk format is LIF.

Retrieving Data from a Memory Card

To retrieve the test results after they have been saved on an SRAM memory card, you will have to run an IBASIC program. The following is a program to transfer data from a memory card to a terminal emulator. You can type the program lines into the IBASIC command line from a terminal emulator. See "[Configuration for Terminal or PC Operation](#)" on page 167.

To enter the data retrieval program:

1. Press TESTS.
2. Select **IBASIC Cntrl** from the **SET UP TEST SET** list (or **IBASIC** from the **Test Function** field).
3. Position the cursor to the IBASIC command field (large field in the upper part of the display) and select it. From the list of characters in the **Choices** field, enter the following IBASIC program statements and commands.
4. Enter **SCRATCH** to delete the previous IBASIC program. Be sure it's saved first.
5. Enter the following program:

```
10 DIM A$(120)
```

Sets the string length to 120.

```
20 ASSIGN @File TO "RES:INTERNAL";FORMAT ON
```

Opens a path to the memory card file called "RES" (for results).

```
30 ON ERROR GOTO 80
```

Exits at end of file if an error is encountered.

```
40 LOOP
```

Extracts file contents.

```
50 ENTER @File;A$
```

Transfers part of the file to the string.

```
60 OUTPUT 9;A$
```

The string is output at the Serial port.

```
70 END LOOP
```

Goes back to get more of the file.

```
80 END
```

End of the program.

6. Press k1 (**Run**) to run the entered IBASIC program.

NOTE:

Difference between Run and Run Test

The USER (**Run**) key, assigned as a default key on the TESTS (**IBASIC Controller**) screen, will start an IBASIC program that is resident in the test set's memory. The USER (**Run Test**) key, assigned as a default key on the TESTS screens, will load and run the program that is called from the **Select Procedure Filename:** and **Select Procedure Location:** entries on the TESTS **Main Menu** screen.

Collection to a PC

Test results can be output through the serial port. A variety of devices can receive the data. An HP Palmtop computer, PC, laptop, or terminal can be used. A terminal emulator can log the test results to a file. Examples of terminal emulator programs are HP AdvanceLink and ProComm, a product of DataStorm Technologies, Inc.

For example: Configuring an IBM-Compatible PC with HP AdvanceLink for DOS

1. Load and run HP AdvanceLink on your PC.
2. Use the following [table 8](#), [table 9](#) and [table 10](#) to set the Global Configuration, Terminal Configuration, and Remote Configuration settings.

Table 8 **Global Configuration Settings**

FIELD	SETTING	FIELD	SETTING
Keyboard	USASCII	Memory Size	32K
Personality	HP	Plotter I/F	None
Language	English	HP Mode	Yes
Terminal Mode	Alphanumeric	Video Type	<i>Select your display type</i>
Remote to	<i>enter PC's serial port #</i>	Forms Path	<i>Enter path if used</i>
Printer I/F	None	Screen Size	<i>Enter the size</i>

Table 9 Terminal Configuration Settings

FIELD	SETTING	FIELD	SETTING
Terminal ID	2392A	Esc Xfer(N)	YES
Local Echo	OFF	ASCII 8 Bits	YES
CapsLock	OFF	FldSeparator	US
Start Col	01	BlkTerminator	RS
Bell	ON	ReturnDef	CR
XmitFnctn(A)	NO	Copy	Fields
SPOW(B)	NO	Type Ahead	NO
InhEolWrp(C)	NO	ROW Size	80
Line/Page(D)	LINE	Host Prmpt Char	D1
InhHndShk(G)	NO	Horiz. Scroll. Incr.	08
Inh DC2(H)	NO	Large [+] Key	+

Table 10 Remote Configuration Settings

FIELD	SETTING	FIELD	SETTING
Baud Rate	4800	SR(CH)	LO
Parity/Data Bits	None/8	Recv Pace	None
Eng Ack	No	Xmit Pace	None
Asterisk	OFF	CS(CB)Xmit	NO
Chk Parity	NO		

To set up for data collection to a PC:

1. Press TESTS.
2. Select **External Devices** from the **SET UP TEST SET** list (or **Edit Cnfg** from the **Test Function** field).
3. Position the cursor to the **Calling Name** field and select it.
4. Using the list of characters in the **Choices** menu, enter **DATA C** (next to **Inst# 1**):

1 DATA C

5. Position the cursor to the **Addr** field and select it.
6. Using DATA keypad, enter **9** and press ENTER :

1 DATA C 9

Calling names can be entered in any order.

Configuration for Terminal or PC Operation

It is preferable to enter long strings of characters into fields using a terminal. The characteristics of the serial port, when used for instrument control from a terminal or terminal emulator, are determined by settings on the test set's I/O CONFIGURE screen.

Set the following:

- **Serial In** to **Inst**
- **IBASIC Echo** to **On**
- **Inst Echo** to **On**

Set the remaining configuration entries to match the settings of your terminal or PC program.

Equivalent Front-Panel Control Characters

The following [table 11](#) lists the terminal/computer keystrokes that equate to front-panel controls. *Each equivalent character must be preceded by the Escape key.*

For example, to remotely access the CONFIGURE screen, you type Esc, C on your terminal/computer. (Be sure to use upper-case C for this example.)

Alternate sequences for 5 commonly-used functions are also available. Hold down the Ctrl (control) key and select the corresponding key for the desired function. (Example: Ctrl/H moves the cursor to the left one space.)

ENTER - ^J or ^M

CANCEL - ^C

BACKSPACE - ^H

KNOB_TURN_CW - ^R

KNOB_TURN_CCW - ^L

Table 11 **Equivalent Front-Panel Control Characters**

Function	Equiv. ESC Char.	Function	Equiv. ESC Char.	Function	Equiv. ESC Char.
CANCEL	!	SAVE	G	PRESET	i
PERCENT MHZ_V	(REF_SET	J	INCR_DIV_10	j
S_KHZ_MV)	METER	K	INCR_SET	k
BACKSPACE	-	AVG	L	INCR_TIMES_10	l
ENTER	.	LO_LIMIT	M	DOWN	m
RELEASE	0	HI_LIMIT	N	UP	n
K1	1	E	R	SEVEN	o
K2	2	F	S	EIGHT	p
K3	3	B	U	NINE	q
K4	4	C	V	FOUR	r
K5	5	D	W	FIVE	s
K1_PRIME	6	A	X	SIX	t
K2_PRIME	7	EEX	Z	ONE	u
K3_PRIME	8	YES_ON_OFF	[TWO	v
ASSIGN	9	NO_PPM_W]	THREE	w
KNOB_TURN_CCW	<	RX	a	ZERO	x
KNOB_TURN_CW	>	TX	b	POINT	y
MSSG	A	DUPLEX	c	PLUS_MINUS	z
HELP	B	PREV	d	OHM_PCT_DEL_DBUV	{
CONFIG	C	TESTS_MAIN	e	DB_GHZ_DBM	
HOLD	D	LOCAL	f	MS_HZ_UV	}
PRINT	E	RECALL	g		
ADRS	F	MEAS_RESET	h		

Disks

Initializing a Disk

If you are starting with a blank disk, you will have to initialize it to the format you have chosen. Disk drives require specific commands to perform initialization. The test set's IBASIC commands to initialize some disks are described here. You should verify that the drive you are using can be controlled by the test set and that you are initializing a disk using a drive or PC that has a compatible format.

To initialize a disk to LIF in an HP-IB disk drive:

1. Verify that the test set **Mode** on the I/O CONFIGURE screen is set to **Control**:
 - a. Press TESTS.
 - b. Select **IBASIC Cntrl** from the **SET UP TEST SET** list (or **IBASIC** from the **Test Function** field).
 - c. Position the cursor to the IBASIC command field and select it.
 - d. With the list of characters in the **Choices** menu, enter the following:

```
INITIALIZE ":,7xx,y"
```

where:

xx = the HP-IB address of the disk drive, and

y = the unit number of the drive.

To initialize a disk to DOS in an HP-IB drive:

Follow the procedure for the LIF format, replacing the INITIALIZE statement with **INITIALIZE "DOS: ,7xx,y"**.

Retrieving Data from a Disk

One way to retrieve the test results from a disk is to run an IBASIC program. A program to transfer data from a disk to a terminal emulator is given below. You can type it into the IBASIC command line from the terminal emulator. Be sure your program is saved, because it will be deleted from programmable memory. The file name for this example is "RES". The disk address is 700, and the drive number is 0. The entire file name is **RES:,700,0**.

To enter the data retrieval program:

1. Press TESTS.
2. Select **IBASIC Cntrl** from the **SET UP TEST SET** list (or **IBASIC** from the **Test Function** field).
3. Position the cursor to the IBASIC command field (large field in the upper part of the display) and select it. From the list of characters in the **Choices** field, enter the following IBASIC program statements and commands.
4. Enter **SCRATCH** to delete the previous IBASIC program. Be sure it's saved first.
5. Enter the following program:

```
10 DIM A$(120)
```

Sets the string length to 120.

```
20 ASSIGN @File TO "RES:,700,0"
```

Opens a path to the file called "RES" (for results).

```
30 ON ERROR GOTO 80
```

Exits at end of file if an error is encountered.

```
40 LOOP
```

Extracts file contents.

```
50 ENTER @File;A$
```

Transfers part of the file to the string.

```
60 OUTPUT 9;A$
```

The string is output at the serial port.

```
70 END LOOP
```

Goes back to get more of the file.

```
80 END
```

End of the program.

6. Press k1 (**Run**) to run the entered IBASIC program.

Exiting a Program

Do not press RX or TX to exit the program. Selecting the RX TEST or TX TEST screen causes signal paths internal to the test set to be modified. If you exit the program to a screen other than RX TEST or TX TEST, the settings necessary to resume testing will be retained.

After you have made the manual settings you want, press the DUPLEX key as a last step before continuing the software. This will cause the test set to be properly set up.

Another way to safely exit is to:

1. Press CANCEL.
2. Press DUPLEX.
3. Press SHIFT SAVE.
4. Using list of characters in the **Choices** menu, enter a register name or number.
5. Select **Done**.
6. Operate the test set manually.
7. Press RECALL.
8. Choose the name of the saved setup.
9. Press TESTS.
10. Press k2 (**Continue**).

HP-IB Control Annunciators

The words, letters, and symbols at the top right corner of the CRT display indicate these conditions:

- **R** indicates remote operation from an external controller or IBASIC program in the test set. This letter will be displayed while the software is running.
- **L** indicates that the test set is listening, and is ready to receive a manual or remote command.
- **T** indicates that the test set is talking to another HP-IB device.
- **S** indicates that a service request has been generated.
- **C** indicates that the test set is currently an active controller. Control mode is set on the I/O CONFIGURE screen. The test set must be a controller if HP-IB peripherals are to be controlled.
- ***** indicates that an IBASIC program is running, or that the IBASIC controller is executing a command.
- **?** indicates that an IBASIC program is waiting for a user response.
- **-** indicates that the IBASIC program is paused.
- **SHIFT** indicates that the SHIFT key was pressed, and that the next key entry will be shifted. (Press SHIFT again to clear).

Memory Cards

Memory cards are inserted into the slot on the test set's front panel. The memory card is powered by the test set while it is inserted. Arrows printed on the memory card and the test set's front panel indicate the direction and orientation of card insertion.

Memory cards are used to store or retrieve the following:

- Software code
- An HP-supplied Procedure, containing:
 - A default TEST sequence
 - Default test parameter values
 - Default pass/fail limit values
- A Library file
- Procedures you make, optimized for your application
- Data collection files
- Channel Information
- User defined keys

Three types of memory cards are available:

- Static Random Access Memory (SRAM)
 - SRAM cards have read and write capability. SRAM cards can be programmed and read with the test set.
- One-Time Programmable (OTP)
 - Once programmed with a suitable card programmer, OTP cards have read-only capability. OTP cards can be read with the test set, but cannot be programmed with the test set.
- Flash Memory
 - Flash cards have read and write capability. They can only be written to, or programmed with a suitable card reader/programmer. Flash memory cards cannot be written to, or programmed with a test set. Flash memory cards can be read by the test set.

NOTE:

Hewlett-Packard-supplied software code and Hewlett-Packard procedure and library files are typically supplied on either OTP cards or flash cards. Flash cards can be distinguished from OTP cards by a small write protect (WP) switch in the end of the flash cards. SRAM cards also have a write protect or safe switch in the end of the card, but they also use a battery. Software and procedure/library files stored on a flash card cannot be overwritten by a test set regardless of the position of the write protect (WP) switch.

The software memory card can be removed after the program is loaded into the test set memory. The program will remain in memory after a power-down/power-up cycle, until a new program is loaded. Loading a new program will replace the existing program.

Loading a Software Upgrade, FW below rev A.12.04 only

If you have purchased a software upgrade from the factory and are loading it for the first time, you must clear the old revision software from the test set memory before running the new revision software. If you do not, the new revision will not be loaded, and the old revision will be used. This is for FW below revision A.12.04 only. For firmware revision A.12.04 and above, the test set will check for differences in the code, and automatically load the most updated version.

The easiest way to clear the old revision software is to load a different software program. The LIST_OPTS program that is stored in internal ROM can be used for this purpose.

**To Load the
LIST_OPTS Program:**

1. Press TESTS.
2. Position the cursor to **Select Procedure Location** and select it.
3. From the **Choices** menu, select **ROM**.
4. Position the cursor to **Select Procedure Filename** and select it.
5. From the **Choices** menu, select **LIST_OPTS**.
6. Press k1 (**Run Test**).

The new revision software can now be loaded.

SRAM Memory Cards

A Static Random Access Memory (SRAM) Card can be used to store test results and procedures you make. The following parts can be used.

Table 12 SRAM Memory Card Products for HP 8920A,D

Memory	Product
32 kilobytes	HP 85700A
128 kilobytes	HP 85702A
256 kilobytes	HP 85704A
512 kilobytes	HP 85705A

Table 13 PCMCIA SRAM Memory Card Products for HP 8920B

Memory	Product
64 kilobytes	HP 83230A
256 kilobytes	HP 83233A
1 megabyte	HP 83231A

SRAM memory cards use a lithium battery (For HP 11807A: part number CR 2016 or HP part number 1420-0383. For HP 11807E: part number CR 2025 or HP part number 1420-0509). Programs and data will be retained for over one year if the memory card is stored at 25° C. The memory card is powered by the test set while it is inserted. Replace the battery while the memory card is inserted into a powered-up test set. To retain data and programs, it should be replaced annually. See the *HP 8920 User's Guide*. The write-protect switch on an SRAM memory card will write protect the card when it is set toward the outside of the card.

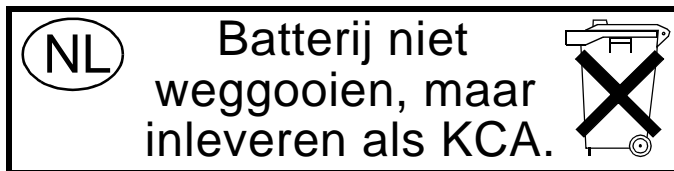

Memory Card Storage Space

Procedures use 12-16 records each. A Library uses 20-35 records. A single library must be included on the card. A record is 256 bytes. Approximately 11 kilobytes of overhead is required on each card.

Use the following formula to estimate the storage space needed:

$$\text{Storage Space (in kilobytes)} = (\text{Number of Procedures} \times 4.1) + 20$$

For example, if you want to save ten different procedures, you will need 61 kilobytes of memory. The 64 kilobyte or 128 kilobyte card is sufficient.

The storage space you need for data collection depends on the number of test results that are saved. You will need approximately 4 kilobytes per page of test results that you save. A page of test results is about 57 lines of CRT or printer output.

The storage space of smaller SRAM cards can be quickly used. If you are collecting large quantities of data, data collection using a PC or printer may be preferable.

Initializing a Memory Card

Initializing HP 11807A cards (Smart Cards) using the TESTS **Save/Delete Procedure** screen automatically defaults to LIF format. Initializing HP 11807E cards (PCMCIA) using the TESTS **Save/Delete Procedure** screen automatically defaults to DOS format. However, initializing cards from the **Save/Delete Procedure** screen is only available on HP 8920B or HP 8920A,D test sets with firmware above revision A.14.00. If these settings do not match your needs, or you have firmware below revision A.14.00, there is another method described below in which you may select the format.

- Press TESTS.
- Select **Save/Delete Procedure** from the **CUSTOMIZE TEST PROCEDURE** list.
- Insert the SRAM card in the slot on the front panel. (Make sure the switch on the card is not in the write-protected position).
- Press k3 (**Init Card**).
- Press Yes if you want to continue.

There are two ways to initialize a memory card to select the format. If you have a terminal emulator attached to the test set, you can type a command into the IBASIC command line. A second way to initialize a card is to run the ROM program RAM_MNG.

To initialize an SRAM card using IBASIC

1. Press TESTS.
2. Select **IBASIC Cntrl** from the **SET UP TEST SET** list (or **IBASIC** from the **Test Function** field).
3. Position the cursor to the IBASIC command line and select it.
4. Using the list of characters under the **Choices** menu, enter the following IBASIC command:

For LIF format: **INITIALIZE ":INTERNAL"**

For DOS format: **INITIALIZE "DOS:INTERNAL"**

To initialize an SRAM card using RAM_MNG

1. Press TESTS.
2. Position the cursor to the **Select Procedure Location** (or **Location**) field and select it.
3. From the **Choices** menu, select **ROM**.
4. Position the cursor to the **Select Procedure Filename** (or **Procedure**) field and select it.
5. From the **Choices** menu, select **IB_UTIL** (or **RAM_MNG**).
6. Press k1 (**Run Test**).
7. Follow the displayed instructions.

NOTE: Loading RAM_MNG will delete any procedure or program in memory.

Retrieving Data from a Memory Card

To retrieve the test results after they have been saved on an SRAM memory card, you will have to run an IBASIC program. The following is program to transfer data from a memory card to a terminal emulator. You can type the program lines into the IBASIC command line from a terminal emulator. See "[Configuration for Terminal or PC Operation](#)" on page 167.

To enter the data retrieval program:

1. Press TESTS.
2. Select **IBASIC Cntrl** from the **SET UP TEST SET** list (or **IBASIC** from the **Test Function** field).
3. Position the cursor to the IBASIC command field (large field in the upper part of the display) and select it. From the list of characters in the **Choices** field, enter the following IBASIC program statements and commands.
4. Enter **SCRATCH** to delete the previous IBASIC program. Be sure it's saved first.
5. Enter the following program:

```
10 DIM A$(120)
```

Sets the string length to 120.

```
20 ASSIGN @File TO "RES:INTERNAL";FORMAT ON
```

Opens a path to the memory card file called "RES" (for results).

```
30 ON ERROR GOTO 80
```

Exits at end of file if an error is encountered.

```
40 LOOP
```

Extracts file contents.

```
50 ENTER @File;A$
```

Transfers part of the file to the string.

```
60 OUTPUT 9;A$
```

The string is output at the serial port.

```
70 END LOOP
```

Goes back to get more of the file.

```
80 END
```

End of the program.

6. Press k1 (**Run**) to run the entered IBASIC program.

NOTE:

Difference between Run and Run Test

The USER (**Run**) key, assigned as a default key on the TESTS (**IBASIC Controller**) screen, will start an IBASIC program that is resident in the test set's memory. The USER (**Run Test**) key, assigned as a default key on the other TESTS screens, will load and run the program that is called from the **Select Procedure Filename** and **Select Procedure Location** entries on the TESTS **Main Menu** screen.

Parameters

Parameters are values you enter that optimize your use of the test software. Many of the parameters are determined by examining your test needs.

Default values are set into the software. Some of these values are derived from standard methods of measurement and some are derived from the industry standard requirements. Load a Procedure and select the **Test Parameters** screen from the **CUSTOMIZE TEST PROCEDURE** list, to see the default values.

You should verify that parameters are properly set after you select the tests to be placed in your procedure.

Parameters remain in battery-backed-up memory until you select a procedure to run. If you wish to prevent them from being lost when a new procedure is selected, you will have to save them in a procedure. See "[Saving a Procedure](#)" on page 198.

To print the parameters list, see "[To print TESTS screens:](#)" on page 192.

To edit a parameter value:

1. Press TESTS.
2. Select **Test Parameters** from the **CUSTOMIZE TEST PROCEDURE** list (or **Edit Parm** from the **Test Function** field).
3. Position the cursor to the **Parm#** field and select it.
4. Rotate the knob to the desired parameter number and select it.
5. Position the cursor to the **Value** field and select it.
6. Enter the desired value using the DATA keypad and press ENTER.
 - a. Use the ← key to backspace.
 - b. Press CANCEL to cancel entries and retain the old value.
7. Press k5 (**Main Menu**) (or TESTS) to return to the TESTS screen.

Pass/Fail Limits (specifications)

Pass/Fail Limits are values you enter that set passing limits for tests. Default values are available in the test software. They have been derived from standard methods of measurement.

Pass/Fail Limits do not have to be changed when you select a test or change the tests in your procedure. Each test has pass/fail limits that apply to it.

You should verify that pass/fail limits are properly set after you select the tests to be placed in your procedure. Lists of the pass/fail limits used by each of the tests are contained in the test descriptions in [chapter 4, "Test, Parameter, and Pass/Fail Limit Descriptions," on page 85](#). A lock is provided to prevent access to the pass/fail limits. See ["Securing a Procedure" on page 202](#). Pass/fail limits remain in the test set's battery-backed-up memory until you select a procedure to run. If you wish to prevent pass/fail limits from being lost when a new procedure is selected, you will have to save them in a procedure. See ["Securing a Procedure" on page 202](#).

To print the pass/fail limits list, see ["To print TESTS screens:" on page 192](#).

To edit a pass/fail limit value:

1. Press TESTS.
2. Select **Pass/Fail Limits** from the CUSTOMIZE TEST SET list (or **Edit Spec** from the **Test Function** field).
3. Position the cursor to the **Spec#** field and select it.
4. Rotate the knob to the desired pass/fail limit number and select it.
5. Position the cursor to the **Lower Limit** or the **Upper Limit** field and select it.
6. Enter desired value using the DATA keypad and press ENTER.
 - a. Use the ← key to backspace.
 - b. Press CANCEL to cancel entries and retain the old value.
7. Position the cursor to the **Check** field and select it.
8. From the **Choices** menu, select the combination of upper and lower limits to be checked.

Pausing or Stopping a TEST

To pause the program, press CANCEL.

To stop the program, press SHIFT then CANCEL. This performs an IBASIC RESET operation.

NOTE:

Changing Settings while Paused

If you make changes to instrument settings while the program is paused, subsequent operation may be unpredictable. Error messages may or may not be displayed. See "[Exiting a Program](#)" on page 171.

To continue a paused program:

1. Press TESTS.
2. Press k1 (**Continue**). The test time is displayed when the test is completed. This time includes the time that the program is paused and the time that it is waiting for connection and inputs to be made. If you are testing through midnight, the test time will not display properly.

Printing

You can print any of the following:

- Test results
- TESTS screens
 - "External Devices" (Edit Cnfg)
 - "Order of Tests" (Edit Seqn)
 - "Channel Information" (Edit Freq)
 - "Pass/Fail Limits" (Edit Spec)
 - "Test Parameters" (Edit Parm)

How to Print (task list) There are five basic steps to printing listed below. A detailed description of each of these steps is at the end of this section.

1. Check to see if your printer is supported by the test set (see ["Supported Printers" on page 184](#)).
2. Determine if your printer requires serial, parallel, or HP-IB connection. Connect the printer to the appropriate port on the test set (see ["Printer Connection" on page 185](#)).
3. Configure the test set for your printer and its interface (see ["Configuring the Test Set for Printing" on page 188](#)).
4. Instruct the test set what to print (see ["To print test results:" on page 189](#)).

Supported Printers

- HP ThinkJet printer
- HP QuietJet printer
- HP PaintJet printer
- HP DeskJet printer
- HP LaserJet printer
- Epson FX-80 printer
- Epson LQ-850 printer

If you do not have one of these printers, consult your printer's manual for the correct printer settings to emulate one of the supported printers.

Printer Connection

HP-IB Connection

An HP-IB printer can be connected to the test set's rear-panel HP-IB connector with an HP-IB cable.

Serial Connection

A serial printer can be attached to the serial port. See [figure 1](#). Use the following RJ-11 pins for this connection.

- RJ-11 Pin 2 - test set Receive Data
- RJ-11 Pin 4 - Ground
- RJ-11 Pin 5 - test set Transmit Data

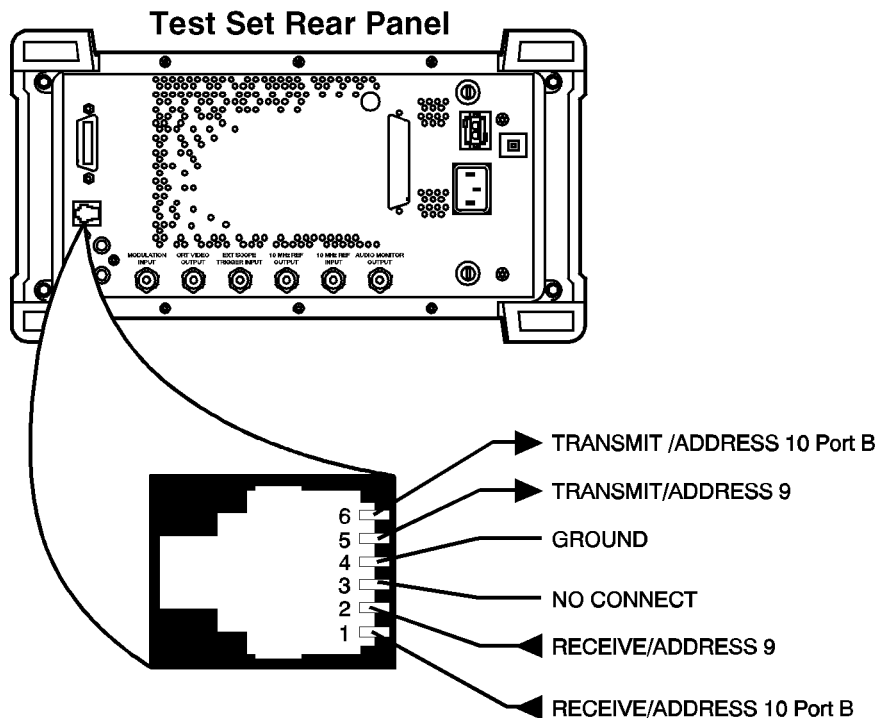

Figure 1 Test Set RJ-11 Serial Port Connectors

Table 14 Hewlett-Packard Printer Cables

Description	Purpose	Quantity	HP Model Number or Part Number
HP-IB (IEEE 488) Cable, 1 meter (3.3 feet)	Test Set to HP-IB Printer	1	10833A
HP-IB (IEEE 488) Cable, 2 meter (6.6 feet)	Test Set to HP-IB Printer	1	10833B
Parallel (IEEE 1284) Printer Cable, 2 meter (6.6 feet)	Test Set to Parallel (Centronics) Printer	1	C2950A
Parallel (IEEE 1284) Printer Cable, 3 meter (9.9 feet)	Test Set to Parallel (Centronics) Printer	1	C2951A
Serial Printer Cable, 4-pin RJ-11 (male) to 9-pin DB-9 (female), 2 meter (6.6 feet)	Test Set to Serial Printer (with 9-pin connector)	1	08921-61038
Serial Printer Cable, 4-pin RJ-11 (male) to 25-pin DB-25 (male), 3 meter (9.9 feet)	Test Set to Serial Printer (with 25-pin connector)	1	08921-61039

Parallel Connection

A parallel printer can be attached to the parallel port. Use the following **figure 2** for pin information.

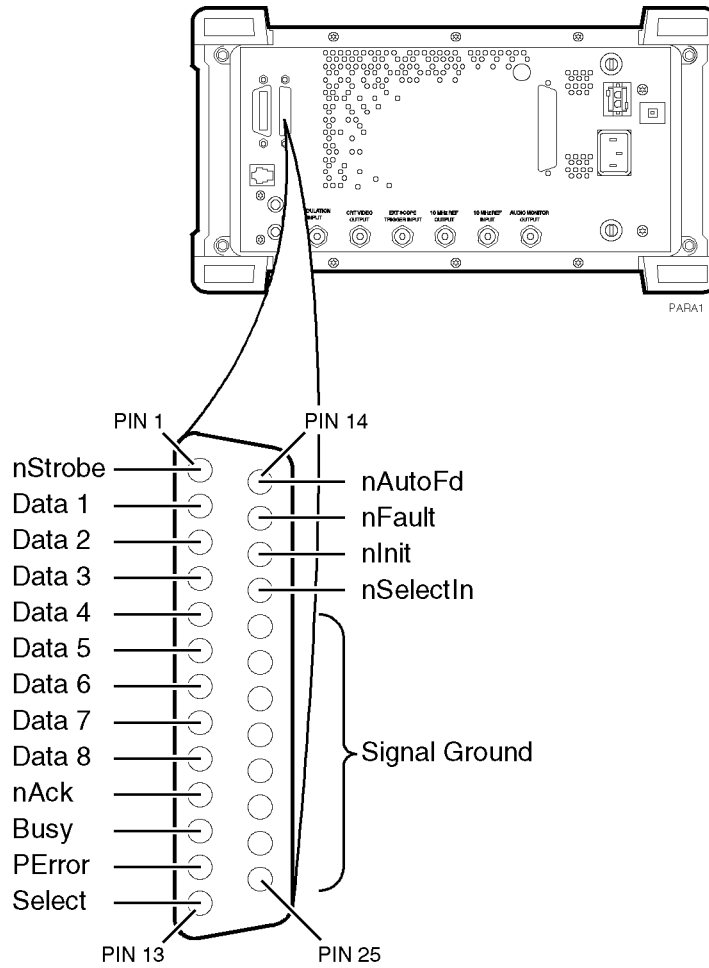

Figure 2 Test Set Parallel Port Connections

Configuring the Test Set for Printing

If using a serial printer, you cannot use the serial port for other connections at the same time, such as Data Collection (saving test results). Serial port connections are shown earlier in this section.

NOTE:

Printer Setup Differences

The HP 8920A,D had several firmware enhancements, which are standard in the HP 8920B. The following **Setup Printer** section applies to users with:

- HP 8920A,D test sets with firmware above revision A.14.00.
- All HP 8920B test sets.

The test set's firmware revision is displayed on the top right corner of the configuration screen.

- Press SHIFT CONFIG to display the configuration screen and read the firmware revision.

If you have an HP 8920A with firmware revision below A.14.00, refer to the next section, titled "To Setup Printer Using HP 8920A FW Below Rev. A.14.00". Contact Hewlett-Packard at 1-800-922-8920 for details on upgrading your firmware if desired. **EXCEPTION:** If you are using A.xx.xx revision software, you can not use the **Printer Setup** screen regardless of your firmware revision. Refer to the instructions for firmware below A.14.00.

To Setup Printer Using Any HP 8920B Or HP 8920A FW Above Rev A.14.00

1. Press TESTS
2. Select **Printer Setup** from the **SET UP TEST SET** list.
3. Position the cursor to **Model** and select the desired printer.
4. Position the cursor to **Print Port** and select the desired port.
5. (If HP-IB only) Position the cursor to **Printer Adrs** and enter the HP-IB address for your printer (0-30).
6. Set the following options if desired:
 - a. Lines/Page (controls the number of lines, 20-120, printed on a page before a form feed is sent to the printer)
 - b. FF at Start (to cause a form feed at the start of a test sequence)
 - c. FF at End (to cause a form feed at the end of a test sequence)
7. From the **To Screen** menu, select **More**.
8. From the **Choices** menu, select **IO CONFIG**.
 - a. For Serial Printing, set the **Serial Baud** field and other serial communications fields listed under it to correspond to your printer's configuration.
 - b. For HP-IB Printing, set the **Mode** field to **Control**.
9. Press TESTS to return to the TESTS (**Main Menu**) screen.

To print test results:

1. Press TESTS
2. Select **Printer Setup** from the **SET UP TEST SET** list.
3. Position the cursor to **Output Results To** and select **Printer**.
4. Position the cursor to **Output Results For** and select **All** if you want all results printed, or **Failures** if you want failures only printed.
5. (Optional) Position the cursor to **Output Heading** and enter your desired heading.

To send Escape Sequences to the printer

If you have revision B.xx.xx software, you may use the test set to send escape sequences to control printer options such as pitch, margins, paper size, and so forth. The software comes with some pre-defined escape sequences compatible with HP printers, listed below, or you have the option to enter others which are compatible with your printer (use your printer's user's manual for the available print features and corresponding escape sequences). This function is not available with revision A.xx.xx software.

The software already has an implied escape character for the first sequence, you need only to enter the escape sequence following the escape character. However, if you are linking two or more sequences together, you must use the ~ to indicate the escape character between each sequence. If the sequence exceeds the space allotted in the options field, you may continue with additional escape sequences in the next available **Options** field. You must however, still enter **Escape Seq** in the **Calling Name** field and the appropriate address in the **Addr** field for all subsequent entries.

How to send an Escape Sequence:

1. Press TESTS.
2. Select **External Devices** from the **SET UP TEST SET** list.
3. Position the cursor to the **Inst#** field and select it.
4. Rotate the knob until an empty **Calling Name** field appears, and select it.
5. Position the cursor to the **Calling Name** field and select it.
6. Select **Escape Seq** from the **Choices** menu.
7. Position the cursor to the **Addr** (address) field and select it.
8. Using the DATA keypad, enter **9** for serial printers, **15** for parallel printers, or **70X** for HP-IB printers, then press ENTER. .
9. Position the cursor to the **Options** field (directly under **Calling Name**) and select it.
10. Select the desired escape sequence from the **Choices** menu if applicable, or enter an appropriate sequence using the list of characters below the choices.

Table 15 **Escape Sequence Definitions for HP Printers**

Escape Sequence	Print Feature
&l66P	Sets page length to 66 lines
&l72P	Sets page length to 72 lines
&l6D	Sets lines per inch to 6 lines
&l8D	Sets lines to inch to 8 lines
(s12h12v6T	Selects 12 characters per inch 12/72 inch character height gothic typeface
&a9L~&l6E	Sets left margin to 9 characters top margin to 6 lines
(s12h12v6T~&a9L~&l6E	Selects 12 characters per inch 12/72 inch character height gothic typeface left margin to 9 characters top margin to 6 lines
&l8d88P	Selects 8 lines per inch 88 lines per page
&l8d96P	Selects 8 lines per inch 96 lines per page
(s16.67h12V~&a17L~&l6E	Selects 16.67 characters per inch 12/72 inch character height left margin to 17 characters top margin to 6 lines

To print TESTS screens:

TESTS screens include:

- "External Devices"
- "Order of Tests"
- "Channel Information"
- "Pass/Fail Limits"
- "Test Parameters"

The same general process is used to print the information for all of the above TESTS screens.

1. Make sure that your printer is properly connected and configured as explained earlier in this section.
2. Press TESTS.
3. Select the **CUSTOMIZE TEST PROCEDURE** screen of your choice.
4. Press k3 (**Print All**) and select it.
5. Press TESTS to return to the TESTS (**Main Menu**) screen.

To Setup Printer Using HP 8920A FW Below Rev A.14.00

1. Press TESTS
2. Select **Edit Cnfg** from the **Test Function** field.
3. Position the cursor to the **Inst#** field and select it.
4. Rotate the knob until an empty **Calling Name** field appears, and select it.
5. Position the cursor to the **Calling Name** field and select it.
6. Using the list of characters in the **Choices** menu, enter the word **Printer**. Select **Done** when complete.
7. Position the cursor to the **Model** field and select it (optional).
8. Using the DATA keypad, enter the Model # and press ENTER.
9. Position the cursor to the **Addr** (address) field and select it.
10. Using the DATA keypad, enter **9** for serial printers, **15** for parallel printers, or **70X** for HP-IB printers, then press ENTER. .
11. Position the cursor to the **Options** field (directly under **Calling Name**) and select it.
12. Using the list of characters from the **Choices** menu, the following commands may be entered. Separate the commands with commas (example; **LN=60 , START , END**)
 - a. **LN** equals the number of printed lines per page.
 - b. **START** causes a form feed at the start of each printout.
 - c. **END** causes a form feed at the end of each printout.
13. From the **To Screen** menu, select **More**.
14. From the **Choices** menu, select **IO CONFIG**.
15. For Serial Printers:
 - a. Set the **Serial Baud** field and other serial communications fields listed under it to correspond to your printer's configuration.
16. For HP-IB Printers:
 - a. Position the cursor to the **Mode** field and select it.
 - b. From the **Choices** menu, select **Control**.
 - c. Position the cursor to the **Print Adrs** field and select it.
 - d. Rotate the knob and select the HP-IB address of your printer.
 - e. Position the cursor to the **Print To** field. Pressing knob will toggle the underlined selection. Select to underline **HP-IB**.
17. Press TESTS to return to the TESTS screen.

To print test results

1. Make sure that your printer is properly connected and configured as explained earlier in this section.
2. Press TESTS.
3. Position the cursor to the **Output Results To:** field (or the **Output Destination** field). Pressing knob will toggle the underlined selection. Select to underline **Printer**.
4. Position the cursor to the **Output Heading** field and select it.
5. Using the list of characters in the **Choices** menu, enter a printout heading (optional). Select **Done** when the heading is complete.

To send Escape Sequences to the printer

If you have revision B.xx.xx software, you may use the test set to send escape sequences to control printer options such as pitch, margins, paper size, and so forth. You may enter sequences which are compatible with your printer (use your printer's user's manual for the available print features and corresponding escape sequences). This function is not available with revision A.xx.xx software.

The software already has an implied escape character for the first sequence, you need only to enter the escape sequence following the escape character. However, if you are linking two or more sequences together, you must use the ~ to indicate the escape character between each sequence. If the sequence exceeds the space allotted in the options field, you may continue with additional escape sequences in the next available **Options** field. You must however, still enter **Escape Seq** in the **Calling Name** field and the appropriate address in the **Addr** field for all subsequent entries.

**How to send an
Escape Sequence:**

1. Press TESTS.
2. Select **Edit Cnfg** from the **Test Function** field.
3. Position the cursor to the **Inst#** field and select it.
4. Rotate the knob until an empty **Calling Name** field appears, and select it.
5. Position the cursor to the **Calling Name** field and select it.
6. Enter **ESCAPE SEQ** using the characters in the **Choices** menu. Select **Done** when you are finished.
7. Position the cursor to the **Addr** (address) field and select it.
8. Using the DATA keypad, enter **9** for serial printers, **15** for parallel printers, or **70X** for HP-IB printers, then press ENTER. .
9. Position the cursor to the **Options** field (directly under **Calling Name**) and select it.
10. Select the desired sequence using the list of characters below the choices.

Table 16 **Examples of Common Escape Sequences**

Escape Sequence	Print Feature
&l66P	Sets page length to 66 lines
&l72P	Sets page length to 72 lines
&l6D	Sets lines per inch to 6 lines
&l8D	Sets lines to inch to 8 lines
(s12h12v6T	Selects 12 characters per inch 12/72 inch character height gothic typeface
&a9L~&l6E	Sets left margin to 9 characters top margin to 6 lines
(s12h12v6T~&a9L~&l6E	Selects 12 characters per inch 12/72 inch character height gothic typeface left margin to 9 characters top margin to 6 lines
&l8d88P	Selects 8 lines per inch 88 lines per page
&l8d96P	Selects 8 lines per inch 96 lines per page
(s16.67h12V~&a17L~&l6E	Selects 16.67 characters per inch 12/72 inch character height left margin to 17 characters top margin to 6 lines

To print TESTS screens

TESTS screens include:

- "Edit Cnfg"
- "Edit Seqn"
- "Edit Freq"
- "Edit Spec"
- "Edit Parm"

The same general process is used to print the information for all of the above TESTS screens.

1. Make sure that your printer is properly connected and configured as explained earlier in this section.
2. Press TESTS.
3. Select the TESTS screen you desire.
4. Press k3 (**Print All**) and select it.
5. Press TESTS to return to the TESTS screen.

Procedures

A procedure is a collection of test parameters, pass/fail limits and a testing order, saved in a file that customizes the test software to a specific application. You may save the file on a memory card or disk.

You do not have to save a test sequence in a procedure. Each test can be stand-alone if desired. After you choose a procedure, you can choose which of the tests you want to run.

When you save a procedure you will only be saving test parameters, pass/fail limits and a testing order. The memory card or disk must also contain a library file. A library file contains the names of all of the test parameters, pass/fail limits and tests that are in the test software. The library you use will be the library that is supplied with your software. When you save your procedure, the library will be automatically saved on the same card or disk.

The procedure(s) supplied with your software will be listed in the **Choices:** column when you select the **Select Procedure Filename:** (or **Procedure**) field. Procedures will be displayed if your software memory card is plugged in.

Saving a Procedure

After you have set up the test software you can save the setup to an SRAM memory card, disk, or internal RAM memory by doing the following.

The memory card or disk you use must be initialized before its first use. See ["Initializing a Memory Card" on page 177](#) or ["Initializing a Disk" on page 169](#). If you are using a disk drive, you may have to enter the **External Disk Specification** into the **TESTS External Devices** screen (or **Edit Cnfg** screen). It will be used when the **Select Procedure Location:** field on the **TESTS** screen is **Disk**.

- To save a procedure:
1. Press TESTS.
 2. Select **Save/Delete Procedure** from the **CUSTOMIZE TEST PROCEDURE** list (or **Proc Mngr** from the **Test Function** field).
 3. Position the cursor to the **Select Procedure Location** (or **Location**) field and select it.
 4. From the **Choices** menu, select the desired location. The media must be initialized before a file can be saved. To initialize an SRAM card (HP 8920B or HP 8920A,D firmware above revision A.14.00 only, otherwise see "[Initializing a Memory Card](#)" on page 177:
 - a. Insert card in the slot on the test set's front panel.
 - b. Press k3 (**Init Card**)
 - c. Press **Yes**. Note: this will delete any procedures or programs from memory.To initialize a RAM disk, see "Memory Cards/Mass Storage" in the *HP 8920B Programmer's Guide*.
 5. Position the cursor to the **Enter Procedure Filename** (or **Procedure**) field and select it.
 6. From the list of characters in the **Choices** menu, enter a filename. Filename must be nine characters or less. When filename is complete, position cursor to **Done** and select it. Procedure filenames that already exist on the card will appear at the top of the list of characters.
 7. If you selected **Card**, insert an initialized memory card into the slot on the test set's front-panel.
 8. Verify that the card or other media is not write-protected. See "[Memory Cards](#)" on page 173.
 9. Position the cursor to the **Enter Description for New Procedure** (or **Comment for new procedure**) field and select it. From the list of characters in the **Choices** menu, enter comments. When the comments are complete, position the cursor to **Done** and select it.
 10. Position the cursor to the **Procedure Library** (or **Library for new procedure**) field and select **Current** (Current underlined). The name of the Library is displayed on the TESTS screen.
 11. Position the cursor to the **Code Location** (or **Program location for new procedure**) field and select it.

From the **Choices** menu, choose memory **Card**, **ROM**, **RAM** or **Disk**. When a procedure is run, the test system will look in this location for a code file if it is not resident in the Test Set's battery-backed-up memory. This location will usually be the software memory card.
 12. Press k1 **Save Proc** (or position the cursor to the **Action** field and select (**Make Procedure**)). A procedure will be saved at the location you chose.
-

Loading a Procedure

A procedure can be loaded from storage media into the test set's battery-backed-up memory by doing the following.

- To load a procedure:
1. Press TESTS.
 2. Position the cursor to the **Select Procedure Location** (or **Location**) field and select it.
 3. From the **Choices** menu, choose the desired location where the procedure is stored and select: **Card, ROM, RAM** or **Disk**.
 4. Position the cursor to the **Select Procedure Filename** (or **Procedure**) field and select it.
 5. From the **Choices** menu, choose the procedure file that you want to load.
 6. Read the **Description** (or **Comment**) field to ensure that the loaded procedure file is the one you want.

Deleting a Procedure

Procedures can be removed from an SRAM memory card, disk or RAM by doing the following.

To delete a Procedure:

1. Press TESTS.
2. Select **Save/Delete Procedure** from the **CUSTOMIZE TEST PROCEDURE** list (or **Proc Mngr** from the **Test Function** field).
3. Position the cursor to the **Select Procedure Location** (or **Location**) field and select it.
4. From the **Choices** menu, select the desired location.
5. Position the cursor to the **Enter Procedure Filename** (or **Procedure**) field and select it.
6. From the **Choices** menu, select the name of the procedure you wish to delete.
7. Press k2 (**Del Proc**) (or position the cursor to the **Action** field and select **Delete Procedure**).
8. Press Yes if you wish to continue.

Securing a Procedure

After you have set up your test software with a testing order, channel information, test parameters, and pass/fail limits, you may wish to secure it. This operation will prevent the viewing and changing of those functions. You can select the items you wish to secure or un-secure. An IBASIC ROM program is stored in the Test Set's firmware to do this.

You can secure the procedure that is supplied with the test software. It is shipped un-secured.

After you make a procedure, you can secure it.

To secure a Procedure:

1. Press TESTS.
2. Position the cursor to the **Select Procedure Location** (or **Location**) field and select it.
3. From the **Choices** menu, select **ROM**.
4. Position the cursor to the **Select Procedure Filename** (or **Procedure**) field and select it.
5. From the **Choices** menu, select **IB_UTIL** (or **SECURE_IT**).
6. Press k1 (**Run Test**).
7. Select the location of the procedure you want to secure: k1 memory (**Card**) or k2 (**RAM**).

NOTE:

RAM refers to the RAM Disk memory within the test set. Before selecting RAM, you must initialize the RAM as a disk. See "[Initializing RAM Disks](#)" on page 205.

8. Proceed with the on-line instructions. You may wish to secure only one of the items, such as pass/fail limits.
9. When you are prompted to enter the **pass number**, enter any sequence of numerals 0 through 9 using the DATA keypad. Enter 9 digits or less.

To un-secure a procedure:

To un-secure a procedure, you must know the **pass number**.

1. Press TESTS.
2. Position the cursor to the **Select Procedure Location** (or **Location**) field and select it.
3. From the **Choices** menu, select **ROM**.
4. Position the cursor to the **Select Procedure Filename** (or **Procedure**) field and select it.
5. From the **Choices** menu, select **IB_UTIL** (or **SECURE_IT**).
6. Press k1 (**Run Test**).
7. Select the location of the procedure you want to un-secure: k1 memory (**Card**) or k2 (**RAM**).
8. Enter the name of the procedure you wish to un-secure.
9. If the procedure has any item secured, you will be asked for the **pass number**.
10. Proceed with the on-line instructions. Select the items you wish to un-secure.
11. When you are prompted, enter the **pass number** using the DATA keypad.

RAM

RAM disk is a section of internal memory that acts much like a flexible disk. Programs can be stored, re-stored, erased, and retrieved.

The RAM disk is partitioned into four separate volumes; 0-3. Each volume is treated as a separate 'disk'. You can also specify the size of each disk in 256-byte increments.

The four RAM disk volumes are designated **:MEMORY, 0, 0** to **:MEMORY, 0, 3**. For example, to catalogue the contents of RAM disk volume '0' from the **IBASIC Cntrl** screen, enter

```
CAT " :MEMORY, 0, 0"
```

Volume 0's contents can be viewed and loaded from the three screens mentioned at the beginning of this section. Volumes 1, 2, and 3 can *only* be accessed from the IBASIC Controller.

NOTE:

RAM Disk Erasure

Any existing programs or formatting on RAM is erased if you use the **RAM_MNG** or **COPY_PL** ROM programs, or the SERVICE screen's **RAM Initialize** function.

Therefore, you should only use RAM disks for short-term storage of files.

Initializing RAM Disks

Each RAM disk volume must be initialized before it can be used. Volume 0 can be initialized using the RAM_MNG procedure stored on the internal ROM's **IB_UTIL** menu. Volumes 1, 2, and 3 must be initialized from the **IBASIC Cntrl** screen.

The optional 'volume size' in the following procedure lets you specify the memory area set aside for each disk in 256 byte blocks.

Follow these steps to initialize volumes 1, 2, or 3:

1. Press TESTS.
2. Select **IBASIC Cntrl** from the **SET UP TEST SET** list.
3. Position the cursor to the data entry field and select it.
4. Using the list of characters from the **Choices** menu, enter the following command:

```
INITIALIZE ":MEMORY,0,<volume number 1-3>",<volume size>
or
INITIALIZE ":MEMORY,0,1",50
```

Saving Tests Results

See "[Data Collection \(Saving and Retrieving Test Results\)](#)" on page 159.

Serial Port

This 6-pin, RJ-11 serial port is used to input and output serial data. Serial data is used for entering programs, printing, and for sending test results to a connected controller, disk drive, or terminal.

Operating Considerations

The serial communications settings are defined on the I/O CONFIGURE screen. Ground is used with both IBASIC and all other serial connections. Transmit B and Receive B are exclusively used with IBASIC programs. Transmit and Receive are used with all other serial connections (see [figure 3](#)).

The IBASIC Controller sends data to and receives data from the serial ports using address **9** for the primary port, and address **10** for Port B.

Use an RJ-11/25-pin RS-232 adapter (HP P/N 98642-66508) and RJ-11 cable (HP P/N 98642-66505) to connect the HP 8920A,B,D to a serial printer or terminal/computer.

NOTE:

RJ-11 Connectors

RJ-11 cables and adapters can be wired several ways. If you buy a cable or adapter other than the HP parts listed, verify the connections for the pins indicated in the following [table 17](#) before connecting cables to the instruments.

The following table lists connections for Transmit, Receive, and Ground pins (address 9).

Table 17 **Connections for Transmit, Receive, and Ground Pins**

HP 8920A,D RJ-11 Serial Port		Terminal/PC 25-Pin RS-232		Terminal/PC 9-Pin RS-232	
Pin 2 (RX)	to	pin 2 (TX)	or	pin 3 (TX)	
Pin 5 (TX)	to	pin 3 (RX)	or	pin 2 (RX)	
Pin 4 (GND)	to	pin 7 (GND)	or	pin 5 (GND)	

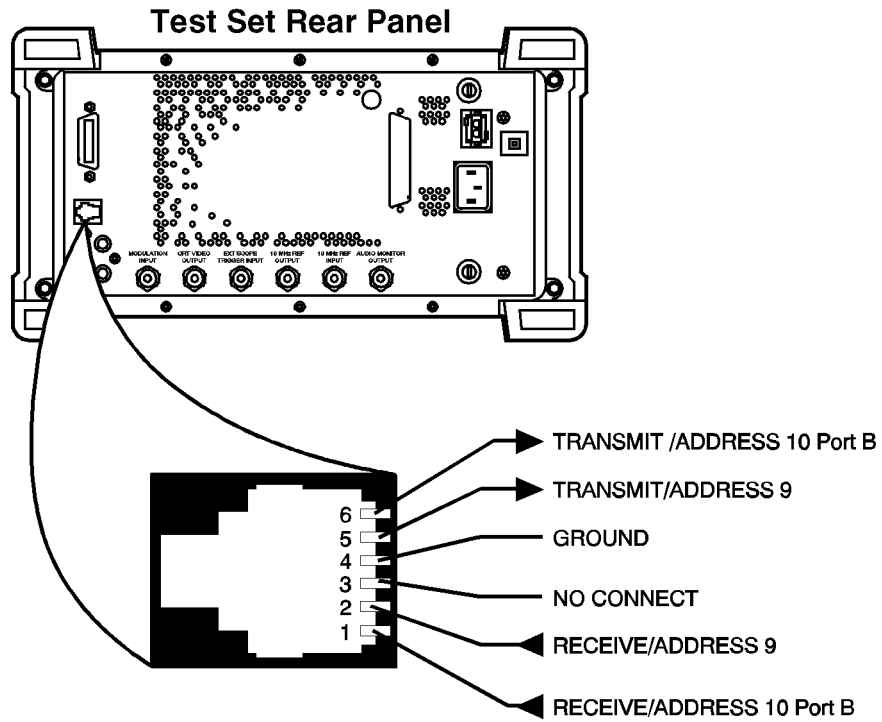

Figure 3 Test Set RJ-11 Serial Port Connections

Test Execution Conditions

In some situations, you may wish to change the way the software works when a test result is obtained. **Test Execution Conditions** allow you to do this.

Test Execution Conditions are accessed from the **SET UP TEST SET** list on the **TESTS (Main Menu)** screen. Press **TESTS**, then select **Execution Cond** to display them. (They are displayed directly on the main **TESTS** screen in firmware below revision A.14.00).

Test Execution Conditions are not retained after a power-down/power-up cycle.

The following **Test Execution Conditions** can be set as needed:

Output Results To: (Output Destination)

You can select either: **Crt** or **Printer** Default:**Crt**

You can specify where test results are to be placed. If you select **Crt**, results will be displayed on the test set's CRT. If you select **Printer**, test results will be sent to the CRT and to a printer. You must connect and configure a printer if you select **Printer**. See "[Printing](#)" on page 184.

Output Results For: (Output Results)

You can select either: **All** or **Failures** Default:**All**

You can specify if you want only the failed results to be displayed or printed. This will be useful if you generally do not print test results, and want to ensure that failed results are displayed or printed.

Output Heading

You can use this field to enter a heading that will be printed or displayed.

Select the **Output Heading** field. Use the knob to choose and enter the characters that you want to appear in the heading.

Choose **Done** when you are finished.

If Unit-Under-Test Fails (If UUT Fails)

You can select either: **Continue** or **stop** Default:**Continue**

If you set this to **stop**, and a pass/fail result is **F**, the program will stop.

Test Procedure Run Mode (Run Mode)

You can select either: **Continuous** or **single step** Default:**Continuous**

You can make tests pause at certain times. If you set this to **single step**, the program will pause after a comparison is made between a test determination and the expected result. For example, tests will pause after the program compares the results to a specification. You can continue from the paused state by pressing k2 (**Continue**).

Autostart Test Procedure on Power-Up

You can select either: **on** or **off** Default: **off**

You can set up the test set so that if the procedure was previously loaded, the procedure will be immediately executed when the test set is powered on.

USER Keys

When you are using the test set, you will see the following USER keys assigned appear at times in the top right corner of the display. These keys are assigned to the hard keys k1 through k5. In many cases, these keys can be used as “shortcuts” instead of positioning the cursor and selecting. USER keys are sometimes referred to as softkeys.

Clr Scr clears the test set’s CRT display.

Continue continues the program after it has been paused.

Delet Stp is used to edit items in a test sequence. When you press this key, the test in the displayed sequence that has its **Step #** highlighted (inverse video) will be deleted. The tests that follow in the sequence will be scrolled up by one step.

Del Proc is used to delete the selected procedure. When you press this key, you will be prompted to verify the command by pressing Yes.

Press **Done** when you want to exit a test or have completed a task. The program will continue if there is a next test in the sequence or if there are additional program steps in the test being run.

Help provides information on how to use the current TEST screen.

Init Card is used to initialize a memory card. Before you press this key, verify that the card is inserted correctly and not in the write-protected position.

Insrt Stp is used to enter items into a test sequence. When you press this key, the test in the displayed sequence that has its **Step #** highlighted (inverse video) will be copied into a new sequence location, immediately after the highlighted one. The tests that follow in the sequence will be scrolled down by one step. This key does nothing if there are no items in the sequence. Choose a test before using this key to insert another.

Main Menu is used to return to the main TESTS screen. The same result is achieved by pressing TESTS.

Page Up\Page Down are used to quickly display items in the list when some of the items won’t fit on the screen.

Run starts an IBASIC program that has been loaded into the test set’s memory.

Run Test loads and runs the program that is called from the procedure that has been entered into the TESTS screen **Select Procedure Filename:** entry. If the program is already loaded into the test set's memory, it will be started.

Save Proc is used to save the specified procedure.

Sngl Step steps the IBASIC program one line at a time. This is different from **Continuous/Single Step** run mode. See "**Test Execution Conditions**" on page 209.

Stop Test pauses the test software.

Take It causes the program to accept the setting of an adjustment, and proceed with the program. The test, determining if the adjustment is within limits, is ceased.

Yes\No are pressed when answering questions displayed on the test set's CRT display.

Problem Solving

If You Have a Problem Testing Your Radio

This section contains information for solving some of the most common problems related to using the HP 11807A,E radio-test software. All problems in this section have a single obvious symptom (shown in bold typeface at the top of each page), but many possible causes (listed in order from the most probable cause to the least probable cause).

NOTE:

If the test set displays an error that states “**One or more self- tests failed**”, you have a hardware problem. In this case, refer to the test set’s *Assembly Level Repair* manual.

If the problem has to do with operating the test set, you’ll want to refer to the MESSAGE screen to list errors or operating messages that have occurred since the instrument was turned on. To do this, press the SHIFT and then the MSSG key.

Also, the *HP Instrument BASIC* manual describes any errors that happen as a result of running IBASIC programs.

If the test procedure doesn't run on a test set

- Check to see that the memory card is correctly inserted into the test set.
- Check to see that a test procedure file has been loaded into the test set.

In the upper left corner of the TESTS (Main Menu) screen, a file name should be seen in the **Select Procedure** field. If the field is blank, then a test procedure file has not been loaded.

To load a test procedure file:

1. Press TESTS.
2. Position the cursor to the **Select Procedure Location** (or **Location**) field and choose **Card** from the **Choices** menu.
3. Position the cursor to the **Select Procedure Filename** (or **Procedure**) field and choose the test procedure file you want from the **Choices** menu.

- Check that you have selected k1 (**Run Test**) to start testing.
- Check the MESSAGE screen to see if an error is causing the test procedure to not run.

If you see the error message “Structures improperly matched” or “Improper context terminator”, the software program was incorrectly loaded into the test set. In this case, refer to the directions on the next page.

NOTE:

Test procedure files are not the actual code or program needed to run the tests. You'll need to load the test procedure file, then run the selected tests with the memory card containing the program code inserted in the memory card slot. The program code remains loaded in the test set until another program is loaded.

If the HP 11807A,E program was incorrectly loaded

An error message like “Structures improperly matched” or “Improper context terminator” appears. It takes 2-4 minutes to load an HP 11807A program when k1 (**Run Test**) is first pressed. It takes approximately 15 seconds to load an HP 11807E program. Thereafter, it takes only a few seconds to run.

- Were the SHIFT CANCEL keys pressed or the memory card removed while the program was loading? If this was done, you will need to clear the RAM, or load another program and then re-load the HP 11807A,E program.

To clear RAM in the test set: (*All SAVE registers are lost.*)

1. Press TESTS.
 2. Position the cursor to **Select Procedure Location** and choose **ROM** from the **Choices** menu.
 3. Position the cursor to **Select Procedure Filename** and choose **IB_UTIL** (or **COPY_PL**) from the **Choices** menu.
 4. Press k1 (**Run test**).
 5. Press k5 (**CLEAR RAM**).
 6. Press TESTS, and re-load and run the test procedure you want.
- Check to see that the test set has enough RAM memory. To see if there's enough RAM memory:
 1. Press TESTS.
 2. Position the cursor to **Select Procedure Location** and choose **ROM** from the **Choices** menu.
 3. Position the cursor to **Select Procedure Filename** and choose **LIST_OPTS** from the **Choices** menu.
 4. Press k1 (**Run Test**).
 5. If the screen displays **OPTIONAL RAM**, your test set has enough RAM memory. If **OPTIONAL RAM** is not displayed, refer to "[Additional Services Available](#)" in [chapter 1, on page 20](#).

If the printer does not print the test results

- Check that the printer is turned on.
- Check that the HP-IB, parallel, or serial cable from the test set to the printer is connected.

If have firmware below revision A.14.00 OR you are using software with Revision A.xx.xx

1. Press TESTS.
2. Check that **Printer** was selected as the **Output Destination** in the **Test Execution Conditions**.
3. Check that the test set is correctly configured for HP-IB, parallel, or serial printing:

For a HP-IB printer:

- a. Check that the printer's **Calling Name** is "PRINTER" and its address is correctly set up in the **External Devices** (or **Edit Cnfg**) screen.
- b. Check that the I/O CONFIGURE screen has been set up correctly:
 - i. Mode=Control
 - ii. Print To=HP-IB
 - iii. Print Adrs=address of your printer

For a parallel printer:

- a. Check that the printer's **Calling Name** is **PRINTER** and its address is set to **15** in the **External Devices** (or **Edit Cnfg**) screen.

For a serial printer:

- a. Check that the printer's **Calling Name** is **PRINTER** and its address is set to **9** in the **External Devices** (or **Edit Cnfg**) screen.
- b. Check that the I/O CONFIGURE screen has been set up correctly for the printer's baud rate, parity, and so forth.

Refer to the test set's *User's Guide* for details about configuring the printer.

**If you have an HP 8920B or HP 8920A,D with firmware above revision A.14.00
AND you are using software with Revision B.xx.xx**

1. Press TESTS.
2. Select **Printer Setup** from the **SET UP TEST SET** list.
3. Check that **Printer** was selected in the **Output Results To:**.
4. Check that the test set is correctly configured for HP-IB or serial printing:
 - a. Select **Model** and choose the most compatible printer model from the **Choices** menu.
 - b. Select **Printer Port** and choose which printer port you are using.
 - c. If the HP-IB port was selected, check that the correct **Printer Adrs** was entered.
 - d. If the Serial port was selected, check that the I/O CONFIGURE screen has been set up correctly for the printer's baud rate, parity, and so forth.

Refer to the test set's *User's Guide* for details about configuring the printer.

If you can't get the data-collection function to work

- Check that you have **DATA C** entered in the TESTS (**External Devices**) (or **Edit Config**) menu.
 1. Press TESTS.
 2. Select the **External Devices** screen, from the **SET UP TEST SET** list (or **Edit Config** from the **Test Function** field).
 3. Position the cursor to the **Calling Name** field, push the knob and enter:
DATA C.
- Check the **Model** field, it should be kept empty since it is not used.
- Check the **Addr** (address) field to make sure the correct address is entered for where the data is to be stored.
 1. If data is to be stored on an SRAM memory card, enter “1” into the **Addr** field.
 2. If data is to be stored on an external computer through the test set's RS-232 serial port (if available), enter “9” into the **Addr** field.
 3. If data is to be stored on an external disk drive over HP-IB, enter an address of “700” or greater into the **Addr** field.
- Check the **Options** field to make sure it is correctly set up:
 1. **For an external disk drive (LIF format) or an SRAM memory card:**
 - a. Enter **ASCII** for saving data as an ASCII file.
 - b. Enter **BDAT** for saving data as a Binary-Data file.
 - c. As an option, you may enter **REC=xxx**, where “xxx” is the number of records for each file. *(The software defaults to 80 records. However, if too small a record size is used, you'll get an “End of file error” when the test is run.)*
 1. **For a DOS disk drive, you may keep the Options field empty, or you may enter any of the following key words:**
 - a. Enter **ASCII** for saving data as an ASCII file.
 - b. Enter **BDAT** for saving data as a Binary-Data file.
 - c. Enter **REC=xxx** for the file's record size, where “xxx” is the number of records for each file. *(The software defaults to 80 records. However, DOS systems automatically change record size if it's too small.)*
 - d. Enter a (**dot extension**) of 3 characters or less for the file name. For example, all model ABCD radio's tested may be organized to have a “.ABC” file extension.

- ❑ Check the test set to make sure it's in the controller mode *if you are using an external disk drive*.
 1. Access the I/O CONFIGURE screen from the **More** field in the **To Screen** menu.
 2. Position the cursor to the **Mode** field and select **Control**.

NOTE:

When the test operator is prompted to enter a file name where data is to be stored, the protocol for the mass-storage device being used must be followed.

Hierarchical directory paths are not allowed, and all files are created with "FORMAT ON".

Also, when initializing a disk, use the following format ("7xx" is the disk address, "y" is the device selector):

DOS disk: INITIALIZE "DOS:CS80,7xx,y"

LIF disk: INITIALIZE ":,7xx,y"

If the AM radio fails the audio tests

- Check the specifications for the AM radio to make sure they match with the pass/fail limits entered in the HP 11807A software.

- Check the audio connections from the AM radio to the test set.

Refer to "**Making a Connection**" in chapter 2, on page 27 for a diagram showing the correct connections.

- Check the AM radio to make sure the microphone is not active and picking up ambient noise.

For a handset type of radio, make sure the handset is on the hook.

For a mobile mount type of radio, make sure the microphone is muted.

- Check the AM radio to see if the audio lines carry other signals.

For example, if the audio lines carry other dc signals, a blocking capacitor in series with the audio signals to/from the test set is required.

If radio volume can't be set on the test set meter screen

- Check that the meter needle on the test set meter screen moves when you turn the radio's volume knob. If the meter needle doesn't move make sure the radio is powered on.
- Check that the radio is correctly connected to the test set. Refer to "**Making a Connection**" in chapter 2, on page 27 for a diagram showing the correct connections.
- If the meter needle moves but cannot be set high enough, check to see if the parameters for setting radio volume are correctly set up. Incorrect settings for any one of these parameters will affect how the test runs.
 1. **Parameter 13. RX Audio Load Impedance** is used by the software whenever radio volume or squelch control is adjusted during testing.
 2. **Parameter 14. RX Maximum Audio Power** sets the full-scale volume level of the meter displayed on the test set. The value you enter for this parameter is scaled up by 50%.
 3. **Parameter 23. RX Tolerance For Setting Volume** sets the tolerance window displayed on the meter screen.

Glossary

CANCEL A key used to pause (stop) the IBASIC program running in the test set.

card Refers to the memory card containing the procedures for testing the unit-under-test.

Choices Refers to a field in the lower right of the screen that displays several possible functions for selection.

Continue Proceed with the IBASIC software program if it has been stopped (paused).

cursor Refers to the brightened region of the screen used to indicate the field/function currently being accessed.

Del Step A function to delete a step in the procedure.

ESD ElectroStatic Discharge - A transfer of electric charge from one place to another. Devices can be damaged by the energy transferred during the discharge.

field An area on the CRT with an inverse video display (**example**) where entries can be made.

function Refers to a particular field, feature, or operation of the test set.

Help A feature providing specific information about how to use the current screen in the TESTS environment. This feature is accessed by pressing k4 (**Help**) from any TEST screen. Note: this feature is only available in the HP 8920B or HP 8920A,D firmware above revision A.14.00.

HELP A feature providing additional test

set information accessed by pressing SHIFT, then TX (HELP) keys. Help topics are listed in alphabetical order.

highlight Refers to the brightened region (cursor) of the screen used to indicate the field/function currently being accessed.

HPF High- Pass-Filter. A filter that increasingly passes signals as their frequency increases towards, and then is greater than, a certain cutoff frequency. In the test set, audio high pass filters are used to reduce the level of low frequency signals during certain measurements.

IBASIC Instrument BASIC is the computer language (code or software) used by the test set's built-in controller. The IBASIC software is downloaded from the OTP CARD into the test set's RAM. This software is then used to control the test set during autotesting the unit-under-test.

initialize A card or disk must be formatted prior to storing data. This may be done by pressing k3 (**Init Card**) on the TESTS (**Save/Delete Procedure**) screen. The default for PCMCIA cards (HP 11807E) is DOS format, and for Epson Cards (HP 11807A,B) is LIF format. See "**Memory Cards,**" in chapter 5, on page 173 for information on changing these default settings.

key (USER keys) Keys refer to any of the push buttons on the front panel of the test set. The USER keys are a specific grouping of keys labeled k1 to k5 which perform the associated numbered function in the action field located in the upper right of the screen. The USER keys are user programmable.

Glossary

knob The large tuning dial for cursor control located in the center of the test set front panel. This knob is rotated to position the cursor on the screen and then pressed to select the particular field or function.

library A collection of the names of all of the parameters, pass/fail limits, and tests in the test software. The test software and the test set's firmware use the library, test software program code file, and a procedure to run a customized application program. A library is stored as a file on a memory card or other mass storage with its associated procedure files.

Location Where to retrieve or save a particular testing procedure, for example, to a disk, card, RAM, or PC.

LPF Low-Pass Filter. A filter that increasingly rejects signals as their frequency increases towards, and then is greater than, a certain cutoff frequency. In the test set, audio low-pass filters are used to reduce the level of high frequency signals during certain measurements.

measurement A series of calculations on data measured by the test set. These calculations provide a value to be compared against pass/fail limit values that verify the performance of the unit-under-test.

Main Menu The screen accessed by pressing the TESTS key, or k5 (**Main Menu**). It is used to customize and execute (run) automated testing.

Also referred to as the "TESTS" screen.

menu The test set's screen displays various tasks to be selected with the cursor

control knob or the USER keys ; this display is the menu.

message The upper portion of the test set's screen is reserved for messages and prompts. Messages give an indication of the status of the test set, for example, **System initialization**.

OTP One Time Programmable (OTP) refers to a CARD on which code or data may only be stored once; similar to ROM. The HP 11807A,E software is shipped on an OTP memory card.

parameters Entries you make for calibration data, radio characteristics, or test customization. They give you flexibility in the way you use the software. Default values for parameters are present in the software.

pass/fail limits Pass/fail limits are the names of criteria verifying the performance of the unit-under-test. Usually, the associated measurement value must fall within the HI/LO limits of pass/fail values to verify performance of the unit-under-test. Default values in the test software have been derived from standard methods of measurement or from the unit-under-test requirements.

pause Using the CANCEL key pauses the running of IBASIC software in the test set and allows access to the keyboard functions. CONTINUE allows the software to proceed.

peak+/- max A detector in the test set that measures and computes the maximum of the absolute value of the positive and negative excursions of the measurement. For example, when an FM waveform with a +10 kHz and -9 kHz deviation is applied, 10 kHz will be displayed.

PRESET Sets the test set to its initial power-up state.

procedure A shortened label for test procedure. A procedure is a collection of channels, parameters, pass/fail limits, and testing order, saved in a file, that customizes the test software to a specific application. Procedures are made by editing existing channels, parameters, pass/fail limits, and testing order, and saving the resulting files to a memory card, disk or internal test set RAM.

prompts The upper portion of the test set (inverse video field) is reserved for prompts and messages. The prompt directs the user to take some action. Messages give an indication of the status of the test set.

RAM Random Access Memory - The memory in the test set that is used to store program code and data. The test set's RAM is battery-backed-up, retaining data and program codes when the power is turned off.

ROM Read Only Memory

Run Test Directs the test set to load the program from the current procedure and begin testing (may take up to two minutes).

save Save and store are used synonymously and refer to putting data or

software on some memory device, such as, card or RAM.

screen Refers to the video display of the test set.

select To choose a particular field or function. Rotate the CURSOR CONTROL knob and position the highlighted cursor on the chosen field or function, then press the knob. An alternative method is to press the numbered USER key having the same number as displayed alongside the desired function.

SINAD Signal plus noise and distortion divided by noise and distortion. A measurement result that determines the quality of an audio tone in the presence of noise and distortion. A 12 dB SINAD value is often used when measuring a receiver's sensitivity.

softkey The name of the set of keys next to the CRT display that can be assigned to certain special actions or fields. The keys are also called USER keys.

SRAM Static Random Access Memory - A data storage device. SRAM memory cards can be used with the test set to save programs and test results.

Step# Orders the sequence of tests, e.g. Step #1 may be Test_5, and Step #2 may be Test_26 and so on.

store Store and save are used synonymously and refer to putting data or software on some memory device, such as card, RAM.

Glossary

tests Tests are a collection of measurements (or a series of other tests) which verify a particular specification value or operation of the UUT. A sequence of tests are contained in a test procedure.

TESTS screen The screen accessed by pressing the TESTS key. It is used to customize and execute (run) all automated testing. Also referred to as the “Main Menu”.

USER keys A group of keys located immediately to the right of the test set’s screen that allow the user to more rapidly select certain functions without rotating and pressing the knob. These key assignments are displayed in the upper right portion of the test set’s screen. The number on the left of the function corresponds to the number on the user key k1 to k5.

values The scalar quantities or numbers inserted in the inverse video fields of the pass/fail limits or parameters. Units of measure (dB, inches, volts, watts, etc.) are contained in the pass/fail limits and test parameters.

Numerics

1-800 help line, 20

A

additional services available, 20
 adjust volume, 118
 AdvanceLink, 164
 AGC circuits
 limits set for testing, 134
 AGC performance
 receiver pass/fail limit, 134
 AGC RF input-signal levels, 134
 AGC RF levels
 receiver test parameters, 109
 AM current
 from power supply, 87
 AM hum and noise, 93
 for the transmitter, 144
 AM hum and noise modulation
 transmitter test parameter, 123
 AM radio
 fails audio tests, 221
 parameters for setting volume, 222
 ASCII file type, 159
 attenuator loss, 17
 audio distortion
 receiver pass/fail limit, 135
 transmitter pass/fail limit, 145
 audio distortion test
 for the receiver, 95
 for the transmitter, 91
 AUDIO IN connector, 112
 audio lines
 carry other signals, 221
 audio output
 of the receiver, 96
 audio power
 maximum, 122, 222
 receiver test parameter, 113
 audio sensitivity, 154
 audio squelch sensitivity test
 for the receiver, 99
 audio testing fails, 221
 audio-distortion modulation
 transmitter test parameter, 124
 audio-frequency response
 reference-frequency test parameter,
 110
 transmitter test parameters, 126
 audio-frequency response error
 receiver pass/fail limit, 136
 transmitter pass/fail limit, 147
 audio-frequency response frequencies
 for the receiver, 111
 audio-frequency response modulation
 transmitter test parameter, 125
 audio-frequency response roll >2500 Hz
 transmitter spec., 146
 audio-frequency response test
 for the receiver, 96
 for the transmitter, 90
 audio-input signal
 for standard test modulation, 92
 audio-load impedance, 222
 receiver test parameter, 112
 audio-output power
 constant level of, 100
 for the receiver, 113
 audio-squelch sensitivity, 142, 143
 is adjusted, 119
 automatic gain control test
 for the receiver, 100
 Autostart, 83
 Autostart Test Procedure on Power-Up,
 210

B

battery drain, [141](#)
 radio specification, [151](#)
BDAT file type, [159](#)
blocking capacitor
 for dc signals, [221](#)

C

cable loss
 for pads and cables, [17](#)
CANCEL, [183](#), [223](#)
capacitor, blocking
 for dc signals, [221](#)
card
 how to insert, [26](#), [58](#)
carrier frequency, [87](#)
carrier power
 at high supply, [149](#)
 at low supply, [150](#)
 for the transmitter, [148](#)
 output rating, [148](#)
CAT IBASIC command, [157](#)
Changing the Order of Tests, [32](#)
channel information
 general description, [36](#)
 securing, [202](#)
channel numbers
 specifying information, [36](#), [68](#)
Choices, [156](#), [223](#)
choose, [156](#)
Clr Scr, [211](#)
configuration
 for data collection, [159](#)
 for terminal or PC operation, [167](#)
CONFIGURE screen
 for printer, [217](#)
configuring an IBM-compatible PC with
 HP AdvanceLink, [164](#)
connecting
 the radio, [26](#), [58](#)
connecting a printer, [185](#)
connections
 parallel printer, [187](#)
 RJ-11 connector, [185](#)
 serial printer, [185](#)
Continue, [211](#), [223](#)
Continue USER key, [183](#)
continuing a paused program, [183](#)
conventions used, [156](#)
COPY IBASIC command, [157](#)
COPY_PL program, [216](#)
copying files, [157](#)
current
 required by AM radio, [87](#)
current drain
 receiver stand-by, [141](#)
 transmitter pass/fail limit, [151](#)
current drain, stand-by, [87](#)
current measurement, [17](#)
current-measuring circuit, [87](#)
cursor, [223](#)
customizing testing, [30](#), [62](#)

D

data collection
 description, 159
 entering the configuration for, 159
 example configuration, 160
 memory card part numbers, 175
 retrieving data, 162, 170, 179
 saving to a memory card or disk, 159
 to a PC, 164
 to a PC, setting up, 166

DC Current Measurement connectors, 17

dc signals
 require a blocking capacitor, 221

dekey between TX tests
 transmitter test parameter, 127

Del Proc, 211

Delet Stp, 211, 223

deleting a procedure, 201

detector
 peak+, 93

detector, rms
 used for audio-frequency response, 90

disk
 initializing, 169
 retrieving data from, 170

disk drive
 External Disk Specification, 198

disk formats, LIF and DOS, 159

distortion
 audio, 91
 harmonic, 91
 the radio's, 100

distortion factor, harmonic
 in transmission, 145

distortion, audio
 testing for, 135

Done, 211

DOS disk format, 159

DOS file type, 159

E

Edit Configuration
 data collection to a PC, 166

Edit Frequency, 36, 68

Edit Parameter, 45, 77

Edit Seqn field, 86

Edit Sequence, 64

Edit Spec, 182

Edit Specifications, 42, 74

EIA standards
 for AM tests, 86

enter, 156

ENTER key, 156

error
 Improper context terminator, 216
 improper context terminator, 215
 Structures improperly matched, 216
 structures improperly matched, 215

errors
 from hardware problems, 214
 from IBASIC, 214
 from operating test set, 214
 on MESSAGE screen, 214

escape sequences, 190
 rev B software with fw below A.14.00,
 194

exiting a program, 171

extreme settings, test at
 test parameter, 108

F

Factory Hot Line, 20

field, 223
 selecting a, 156

file name
 disk example, 170

file types, ASCII, BDAT, DOS, and HP-
 UX, 159

files
 copying, 157

flash
 memory cards, 173

frequency
 editing values, 36, 68
 general description, 68

frequency error
 transmitter pass/fail limit, 152

frequency error test
 for the transmitter, 87

frequency information, secured, 131

frequency stability, 152

front-panel control characters, 167

G

gain control, automatic, [100](#)

H

hardware configurations, [16](#)
hardware errors, [214](#)
harmonic components
 in audio distortion, [95](#)
harmonic distortion, [91](#)
harmonic distortion factor
 in transmission, [145](#)
Help, [211](#)
high-power voltage setting
 test parameter, [105](#)
high-supply voltage
 test parameter, [105](#)
HP-IB
 power supply, [17](#)
HP-IB control
 of the power supply, [108](#)
HP-IB control annunciators, [172](#)
HP-IB printer, [188](#), [217](#)
HP-IB printer connections, [185](#)
HP-UX file type, [159](#)
hum and noise
 AM, [144](#)
 level, [144](#)
 levels measured, [138](#)
 ratio, [137](#), [138](#)
 squelched, [137](#)
 unsquelched, [138](#)
hum and noise AM modulation
 transmitter test parameter, [123](#)
hum and noise squelched
 for the receiver, [137](#)
hum and noise test
 for the receiver, [94](#)
hum and noise, AM, [93](#)

I

IBASIC, [223](#)
 copying files, [157](#)
 initializing a disk, [169](#)
 initializing RAM, [205](#)
 retrieving data from a card, [162](#), [179](#)
 retrieving data from a disk, [170](#)
 TESTS screen, [30](#), [62](#)
IBASIC commands
 entering from a terminal, [157](#)
IBASIC errors, [214](#)
If Unit-Under-Test Fails, [210](#)
If Unit-Under-Test-Fails, [51](#)
If UUT Fails, [210](#)
impedance
 audio load, [112](#)
impedance, audio load, [222](#)
Improper context terminator
 error, [216](#)
improper context terminator
 error, [215](#)
Init Card, [211](#)
initialized
 when the Test Set is, [107](#)
initializing, [223](#)
initializing a disk, [169](#)
initializing an SRAM memory card, [177](#)
initializing RAM disks, [205](#)
Insrt Stp, [211](#)

L

library, 224
 definition, 47, 79
 saving, 47, 79, 198
 LIF disk format, 159
 loading a procedure, 200
 loading software, 26, 58
 loading software upgrade, 174
 Location, 29, 61, 224
 low-power voltage setting
 test parameter, 106
 low-supply voltage
 test parameter, 106

M

Main Menu, 211, 224
 maximum audio power
 receiver test parameter, 113
 maximum battery drain, 141
 measurement, 224
 measurements, 86
 memory card, 223
 memory cards
 are used for, 173
 determining whether it is OTP, flash, or
 SRAM, 173
 flash, 173
 how they're powered, 173
 initializing, 177
 inserting, 173
 OTP, 16, 173
 removing, 174
 retrieving data from, 162, 179
 saving data to, 159
 software, 26, 58
 SRAM, 16, 173
 SRAM battery part number, 175
 Static Random Access Memory
 (SRAM), 175
 storage space needed, 176
 write protect switch, 175
 MESSAGE screen errors, 214
 meter needle
 for setting radio volume, 222
 meter screen
 for setting radio volume, 222
 full-scale reading, 122
 percentage of error, 122
 volume level, 113
 MIC/ACC connector, 130
 microphone
 not active, 221
 microphone and accessory connector,
 130
 microphone input, 128
 microphone sensitivity, 154
 iterative measurement of, 128
 transmitter pass/fail limit, 153
 transmitter test parameter, 128
 microphone sensitivity modulation
 transmitter test parameter, 129
 microphone sensitivity test
 for the transmitter, 92
 microphone voltage, 92
 modulation
 AM hum and noise, 123
 measured at the microphone input, 128
 microphone sensitivity, 129
 modulation frequencies
 to test TX audio-frequency response,
 126
 modulation if set and measure
 for the transmitter, 154
 modulation percentage
 for audio distortion, 124
 for testing TX audio-frequency re-
 sponse, 125
 setting the, 121

N

No, 211
noise
 AM modulation test parameter, 123
 noise level, AM hum and, 93
nominal (normal) power-supply voltage,
 107
nominal supply voltage, 89
 test parameter, 107

O

On UUT Failure, 83
operating errors, 214
Optional RAM message, 216
order of tests
 printing, 184
 saving, 199
OTP
 memory cards, 173
OTP card, 224
OTP memory cards, 16
Output Destination, 83, 209
Output Heading, 51, 83, 209
output impedance
 of receiver circuitry, 112
output power test
 for the transmitter, 88
Output Results, 83, 209
Output Results For, 51, 209
Output Results To, 51, 209
output signal power, 94

P

Page Down, 211
Page Up, 211
parallel printer connections, 187
parameters, 224
 editing values, 45, 77, 181
 for setting radio volume, 222
 general description, 45, 77, 181
 printing, 184
 saving, 47, 79, 181, 199
 securing, 202
part numbers
 memory card battery, 175
 SRAM Memory Cards, 175
pass number, 202
pass/fail limits, 224
 default values, 132
 descriptions, 132
 editing values, 42, 74, 182
 general description, 42, 74, 182
 printing, 184
 saving, 182, 199
 securing, 202
pause, 224
pausing a test, 183
PC
 collecting data to, 164
power requirements
 for the transmitter, 149, 150
power settings, 112
power supplies, 17
power supply
 external, 149, 150
 set up in the TESTS menu, 105, 106,
 107, 108
 the radio's external, 105, 106
power supply current, 87
power-supply measurements, 89
power-supply voltage
 nominal (normal) value, 107
PRESET, 26, 58, 225
print options
 pitch, margins, paper size, typeface,
 190, 194
printer
 does not print, 217
 HP-IB, 188
 HP-IB or serial, 217

output heading, 209
 serial, 188
 printers supported, 184
 printing, 184
 test results, 209
 test results using firmware above revision A.14.00, 189
 test results using firmware below revision A.14.00, 194
 TESTS Screens, 192, 197
 using A.xx.xx revision software, 188
 Procedure, 29, 61
 procedure, 86, 225
 deleting, 201
 general description, 47, 79, 198
 loading into test set memory, 200
 names, 198
 saving, 47, 79, 198
 securing, 202
 un-securing, 203
 what is saved, 198
 program
 exiting a program, 171
 incorrectly loaded, 216
 stored in test set memory, 174
 programmable power supplies, 17
 programmable power supply, 89

Q

quick, general tests
 for the receiver, 101
 for the transmitter, 102

R

radio
 channel security, 131
 connecting, 26, 58
 dekey between TX tests, 127
 keying, 130
 microphone sensitivity, 128
 operator to de-key, 127
 security, 131
 transmit continuously, 127
 radio distortion, 100
 radio power-supply voltage
 normal value, 107
 radio standards
 for AM, 86
 radio volume
 can't be set, 222
 control, 122
 for the receiver is set, 118
 manually setting, 122
 parameters, 222
 receiver test parameter, 118
 RAM, 225
 disk, 204
 initializing, 204
 memory extension, 16
 RAM memory
 enough for the test set, 216
 Random-Access Memory cards, 16
 REC=
 default entry, 161
 entering record number, 160
 REC= to set record size, 160
 receiver
 AGC performance pass/fail limit, 134
 AGC RF levels to sweep across, 109
 audio distortion, 95
 audio distortion pass/fail limit, 135
 audio output response, 96
 audio power output, 135
 audio-frequency response, 96
 audio-frequency response error pass/fail limit, 136
 audio-frequency response frequencies, 111
 audio-frequency response test parameter, 110
 audio-load impedance, 112

-
- audio-squelch sensitivity, 99
 - automatic gain control, 100
 - current drain, 87
 - frequency security, 131
 - hum and noise, 94
 - hum and noise pass/fail limit, 138
 - hum and noise squelched pass/fail limit, 137
 - maximum audio power test parameter, 113
 - quick, general tests, 101
 - radio volume is set, 118
 - sensitivity signal-to-noise, 97
 - sensitivity signal-to-noise level, 116
 - sensitivity signal-to-noise pass/fail limit, 139
 - sensitivity SINAD, 98
 - sensitivity SINAD level, 117
 - sensitivity SINAD pass/fail limit, 140
 - sensitivity SINAD set and measure, 115
 - signal-to-noise sensitivity set and measure, 114
 - squelch sensitivity pass/fail limit, 142
 - squelch sensitivity when setting volume, 119
 - standard RF input level, 120
 - standard test modulation, 121
 - stand-by current drain pass/fail limit, 141
 - tight-squelch sensitivity pass/fail limit, 143
 - tolerance for setting volume, 122
 - receiver squelch, 99
 - Residual AM hum and noise test
 - for the transmitter, 93
 - residual output power, 94
 - retrieving data from a memory card, 162
 - RF carrier-output power, 148
 - RF generator's
 - output level, 114, 115, 120
 - RF input level
 - for the receiver, 120
 - RF input-signal levels
 - variable AGC, 134
 - RF level
 - is swept, 100
 - used to sweep receiver for AGC level, 109
 - RF signal level
 - to produce SINAD at receiver output, 98
 - RF signal source
 - for adjusting volume control, 119
 - RJ-11 connectors, 207
 - rms detector
 - used for audio-frequency response, 90
 - ROM, 225
 - Run, 211
 - Run Mode, 83, 210
 - Run Test, 211, 225
 - difference between Run and, 163, 180
 - running tests, 22
 - overview, 24, 56
- S**
- save, 225
 - SAVE IBASIC command, 157
 - Save Proc, 211
 - SAVE registers lost, 216
 - saving
 - procedure, 47, 79
 - test procedure, 47
 - test results, 159
 - saving a procedure, 198
 - secure frequency information, 131
 - SECURE IT ROM program, 202
 - securing a procedure, 202
 - security
 - for the radio, 131
 - select, 156, 225
 - sensitivity
 - audio squelch, 143
 - for the microphone, 154
 - industry standard, 139
 - microphone, set and measure, 128
 - of the modulator, including microphone, 153
 - sensitivity levels
 - are measured, 99
 - sensitivity signal-to-noise level
 - receiver test parameter, 116
 - sensitivity signal-to-noise test
 - for the receiver, 97
 - sensitivity signal-to-noise
 - receiver pass/fail limit, 139
 - sensitivity SINAD
 - for the receiver, 115
 - receiver pass/fail limit, 140
 - sensitivity SINAD level
 - for the receiver, 117
 - sensitivity SINAD test
 - for the receiver, 98
 - sensitivity, microphone, 92
 - transmitter pass/fail limit, 153
 - sensitivity, reference, 120
 - sensitivity, signal-to-noise
 - receiver test parameter, 114
 - set and measure, 114
 - sensitivity, squelch
 - receiver test parameter, 119
 - sequence
 - changing, 32
-

- editing, 64
 - general description, 32, 64
 - saving, 47, 79
 - Serial Port, 207
 - serial port connections
 - figure, 207
 - serial printer, 188, 217
 - serial printer connections, 185
 - signal-to-noise
 - and distortion ratio (SINAD), 140
 - signal-to-noise and distortion sensitivity
 - SINAD level, 115
 - signal-to-noise sensitivity
 - iterative measurement of, 114
 - signal-to-noise, sensitivity, 97
 - signal-to-noise, sensitivity level
 - receiver test parameter, 116
 - SINAD, 225
 - receiver sensitivity pass/fail limit for, 140
 - SINAD level
 - is within specified limits, 115
 - receiver sensitivity, 117
 - Sngl Step, 211
 - softkey, 225
 - softkeys, 211
 - software
 - how to load, 29, 61
 - loading, 26, 58
 - overview, 25, 56
 - stopping the, 183
 - software revision A.xx.xx
 - printer setup, 188
 - software upgrade
 - loading, 174
 - special display conventions used, 156
 - specifications
 - editing values, 42, 74
 - general description, 42, 74, 182
 - saving, 47, 79
 - specifying channel information
 - general description, 36, 68
 - squelch control, 113
 - squelch sensitivity, 113
 - audio, 142, 143
 - receiver test parameter, 119
 - RF input when setting volume, 119
 - threshold, 142
 - tight, 143
 - SRAM, 225
 - memory cards, 173, 175
 - SRAM memory cards, 16
 - standard RF input level
 - receiver test parameter, 120
 - standard RF signal
 - for audio distortion, 95
 - standard test modulation, 92
 - receiver test parameter, 121
 - standards
 - for AM tests, 86
 - stand-by current drain
 - receiver pass/fail limit, 141
 - stand-by current drain test, 87
 - Stop Test, 211
 - stopping a test, 183
 - stopping the program
 - using Test Execution Conditions, 51, 83, 209
 - Structures improperly matched
 - error, 216
 - structures improperly matched
 - error, 215
 - supply voltage
 - test parameter for normal value, 107
- T**
- Take It, 211
 - terminal emulator, 170
 - configuration, 167
 - DataStorm Technologies, Inc. Pro-Comm, 164
 - HP AdvanceLink, 164
 - test at extreme settings
 - test parameter, 108
 - Test Execution Conditions, 51, 83, 209
 - Test Function
 - Edit Frequency, 68
 - Edit Parameter, 45, 77
 - Edit Sequence, 64
 - Edit Specifications, 42, 74
 - Procedure Manager, 47, 79
 - Test Functions, 62
 - test modulation, 92
 - test parameters
 - default values, 103
 - descriptions, 103
 - editing values, 181
 - general description, 181
 - test procedure, 47
 - saving, 198
 - Test Procedure Run Mode, 51, 210
 - test procedures
 - don't run, 215
 - to load, 215
 - test results
 - printing using firmware above revision A.14.00, 189
 - printing using firmware below revision A.14.00, 194
 - retrieving from a disk, 170
 - retrieving from a memory card, 162, 179
 - saving, 159
 - security, 131
 - where sent, 209
 - Test Set
 - keying the UUT, 130
 - test time, 183
 - testing order
 - securing, 202
 - testresults
 - output failures, 209
 - tests, 226

-
- entering a sequence of, [32](#), [64](#)
 - environment and conditions, [45](#), [77](#)
 - pausing or stopping, [183](#)
 - reference information, [86](#)
 - required order, [86](#)
 - running, [22](#)
 - TESTS (Pass/Fail Limits) screen
 - entering into, [182](#)
 - TESTS screen, [226](#)
 - threshold sensitivity, [99](#)
 - tight-squelch sensitivity, [99](#), [143](#)
 - receiver pass/fail limit, [142](#), [143](#)
 - timebase
 - High-Stability, [17](#)
 - tolerance for setting volume
 - receiver test parameter, [122](#)
 - tolerance window
 - for setting volume, [122](#), [222](#)
 - transmit continuously, [127](#)
 - transmitter
 - AM hum and noise modulation, [123](#)
 - AM hum and noise pass/fail limit, [144](#)
 - audio distortion, [91](#)
 - audio distortion pass/fail limit, [145](#)
 - audio-distortion modulation, [124](#)
 - audio-frequency response, [90](#)
 - audio-frequency response error, [147](#)
 - audio-frequency response frequencies, [126](#)
 - audio-frequency response modulation, [125](#)
 - audio-frequency response roll >2500 Hz, [146](#)
 - battery drain, [151](#)
 - carrier output-power pass/fail limit, [148](#)
 - carrier power at high supply pass/fail limit, [149](#)
 - carrier power at low supply pass/fail limit, [150](#)
 - current drain, [87](#)
 - current drain pass/fail limit, [151](#)
 - dekey between TX tests, [127](#)
 - frequency error, [87](#)
 - frequency error pass/fail limit, [152](#)
 - frequency security, [131](#)
 - frequency stability, [152](#)
 - harmonic distortion factor, [145](#)
 - keying, [130](#)
 - microphone connections for, [130](#)
 - microphone sensitivity, [92](#)
 - microphone sensitivity modulation, [129](#)
 - microphone sensitivity pass/fail limit, [153](#)
 - microphone sensitivity set and measure, [128](#)
 - modulation set and measure pass/fail limit, [154](#)
 - output power, [88](#)
 - quick, general tests, [102](#)
 - residual AM hum and noise, [93](#)
 - user/system key the UUT, [130](#)
 - U**
 - upgrade
 - loading software upgrade, [174](#)
 - usable sensitivity
 - iterative measurement of, [115](#)
 - user key, [156](#)
 - USER keys, [211](#), [226](#)
 - user/system key the UUT
 - for the transmitter, [130](#)
 - UUT keyed
 - by user or the Test Set, [130](#)
-

V

voltage

- for extreme measurements, [89](#)
- high supply, [105](#)
- low supply, [106](#)
- when testing extreme, [105](#), [106](#)

volume

- adjusting or setting on radio, [118](#)
 - can't be set, [222](#)
 - full-scale level, [222](#)
 - manually setting, [122](#)
 - tolerance for setting, [122](#)
- volume control, [122](#)
- volume level
- of the meter screen, [113](#)

Y

- Yes, [211](#)

Z

zero

- the current-measurement circuit, [87](#)